

Secure your systems and components with safety relief valves from WITT

The most effective protection against overpressure from 5 mbar to 45 bar / 0.07 psi to 650 psi



PROTECTION AGAINST OVERPRESSURE

WITT safety relief valves safeguard pipes, pressure vessels and system components from excessive gas pressure

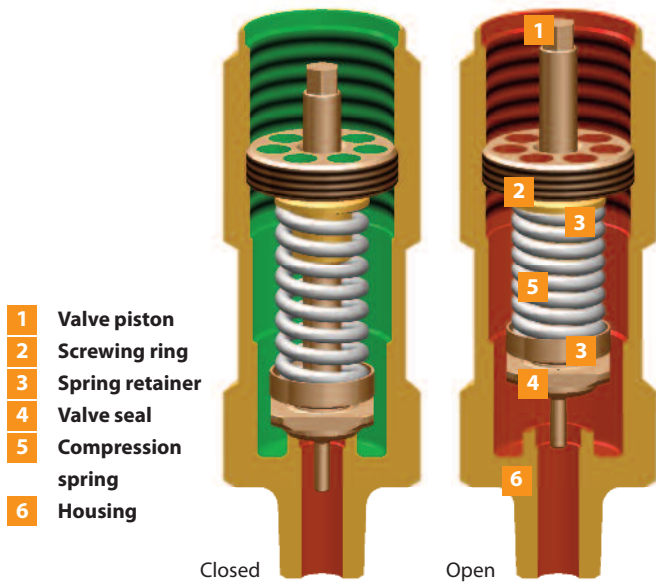

FUNCTION

WITT safety relief valves are spring loaded, direct-acting safety relief valves. As soon as the set opening pressure is reached, a spring-loaded element in the valve triggers and opens for blowing off. After the pressure equalisation, the valve closes automatically and would respond again immediately in the event of a renewed pressure increase. Depending on the gas and application, the valves can either blow off freely or be connected to a blow-off pipe. The opening pressure is set at the factory for WITT valves, appropriate to the permissible operating pressure of the system to be protected.

MATERIALS

WITT safety relief valves are made from high-quality materials. They are extremely robust and suitable for a wide variety of gases and applications. Brass is normally the standard material used for housings in numerous applications. For aggressive and corrosive gases, the housings are made from high-quality stainless steel (1.4541/AISI 321, 1.4404/AISI 316L, 1.4305/AISI 303 or 1.4571/AISI 316Ti). Depending on the gas type and customer requirement, diverse sealing materials are available, ensuring safety even under the most demanding conditions.

For operators of pressurised systems and components they are the last line of defense before excess pressure becomes a disaster: Safety relief valves. Safety relief valves from WITT provide effective protection against overpressure by blowing off vapours and gases from pipes, pressure vessels and system components. WITT offers individually tested safety relief valves with individually adjustable opening pressures from 5 mbar to 45 bar / 0.07 psi to 650 psi. Their small size, position-independent installation and sturdy materials allow a wide range of applications. WITT safety relief valves are available in brass, stainless steel or aluminium, also as a manually ventilated version as well as with or without condensate outlet. On request, the individually set opening pressures can be certified with a TÜV (German Technical Inspectorate) certificate.

APPLICATIONS

TANK CONSTRUCTION

No matter whether transport containers, storage tanks, biogas tanks or mixing and metering vessels – WITT safety relief valves protect diverse applications in the area of tank construction, even against the lowest overpressures.

INDUSTRIAL FURNACE CONSTRUCTION

Industrial furnace construction often involves working with protective gas atmospheres. The process chambers should be protected against overpressure – ideally with safety relief valves from WITT.



CONNECTIONS

You can order WITT safety relief valves with various connections. Besides the standard versions with normal male and female threads, designs with KF or CF flanges, VCR or UNF threads are also available. Adapters are available for connecting to blow-off lines.

CERTIFIED QUALITY

Modern production and a comprehensive quality management system guarantee the highest WITT quality for your safety. WITT safety relief valves are manufactured in accordance with best engineering practices and the relevant safety regulations for design, material selection and resistance. For maximum security, WITT typically offers a 100% component test for the model series SV805/SV805A, in other words, every safety valve of this series is individually pre-tested to ensure fault-free reliability before it is delivered. On request, we can also supply an individual acceptance by TÜV with a certificate (module F according to 97/23/EC) as verification that the opening pressure of each individual valve is correctly set.

THE BENEFITS OF WITT SAFETY RELIEF VALVES

- Minimum opening pressures make even the smallest pressure rises controllable
- Opening pressure individually adjustable depending on the model in the range from 5 mbar to 45 bar / 0.07 psi to 650 psi
- High blow-off volume up to approx. 970 m³/h / 34,240 scfh
- Diverse applications for all technical gases in the temperature range from -40°C to + 300 °C / -40 °F to 572 °F (varies depending on model)
- Suitable for O₂
- 100 % component testing for maximum safety (SV805/SV805A)
- TÜV certificate verifies the individually set opening pressure on request
- Compact construction and location-independent installation for problem-free assembly
- Optionally available in brass, stainless steel and aluminium (AV919)
- Sealing material corresponding to the gas type or on customer request
- Various inlet and outlet connections, adapter for connection to a blow-off pipe
- Some models optionally with condensate outlet
- Some models with manual ventilation function
- Free of oil and grease

INSULATORS AND REACTORS

Insulators and glove box systems frequently involve work in a protective gas atmosphere. WITT safety relief valves protect the housing and the reactors installed to clean the inert gas against overpressure and ensure safe work.

PIPES AND PLANT CONSTRUCTION

Pipes with various gases must be protected against overpressure in pipes and system construction. This can involve simulation systems, research plants, systems and pipes for recovering helium or also supply facilities for nitrogen shielding in the semiconductor industry.

HYDROGEN VEHICLES

Hydrogen-powered vehicles must be protected with safety valves in line with the regulation EC 79/2009. WITT offers a safety relief valve specially approved by the Kraftfahrt-Bundesamt (German Federal Motor Transport Authority) for this purpose, thereby satisfying the highest requirements.



ROBUST ALL-ROUNDER

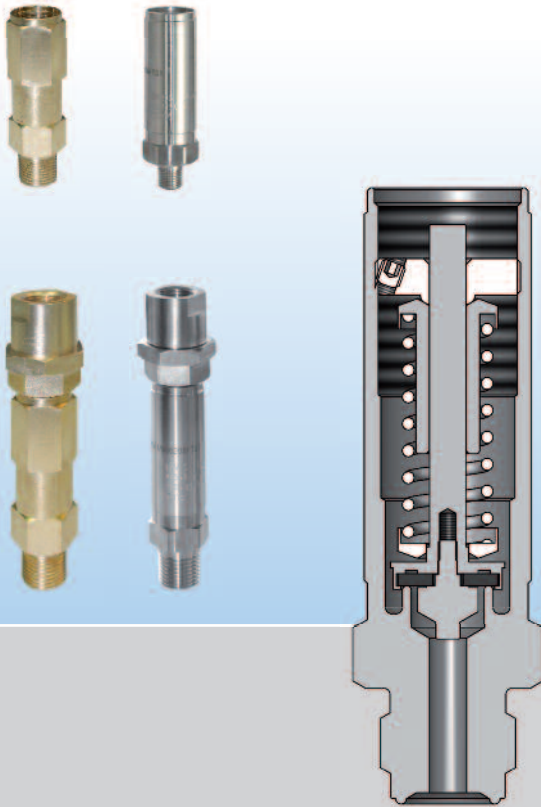

SV805 AND SV805A

- A classic among WITT safety relief valves
- Reliably protects tanks and pipes against excess pressure
- Individual opening pressure between 0.5 and 45 bar / 7 psi and 652 psi
- Maximum volume flow up to approx. 665 m³/h / 23,470 scfh for air
- Compliant with Pressure Equipment Directive 97/23/EC
- Compact size
- Installation irrespective of position
- Suitable for numerous applications
- On request, also available with a condensate outlet
- Model SV805A also has a ventilation function, allowing functionality testing at any time when installed
- TÜV individual certification (module F according to 97/23/EC)

MATERIALS

SV805/SV805A

Housing: Brass 2.0402, stainless steel 1.4404 or 1.4541

Seal: CR, EPDM, FFKM, FPM, HNBR, Isolast 9610, VMQ

SENSITIVE AND STRONG

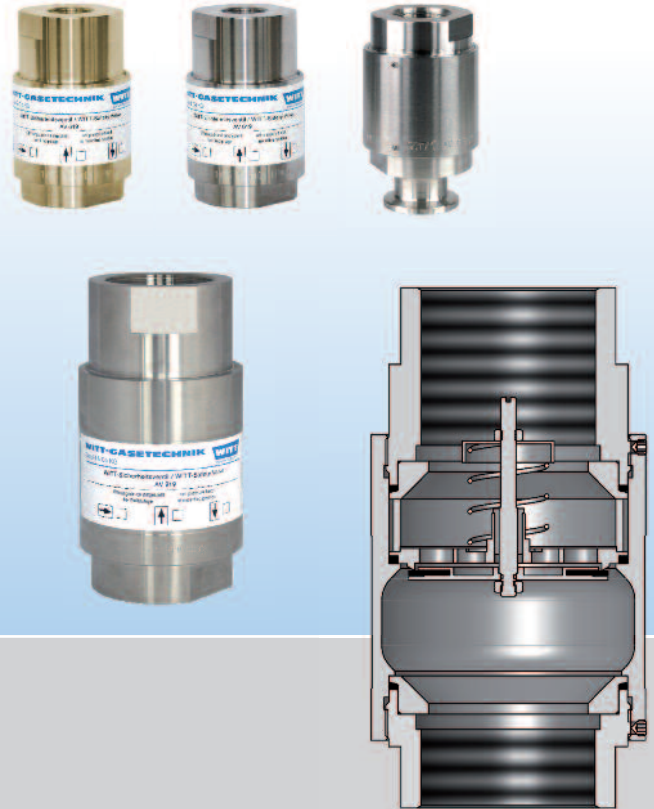

AV619 AND AV919

- The best choice for protection against minimum overpressures at high blow-off volumes
- The highest response sensitivity in the range from 5 to 500 mbar / 0.07 to 7 psi makes even the smallest pressure rises manageable
- Maximum blow-off volume up to approx. 970 m³/h / 34,240 scfh for air
- Reliable protection for tanks, pipes and other system components
- Can also be used as vacuum valves for securing an underpressure owing to the high density and a low leakage rate
- Installation irrespective of position
- TÜV certificate verifies the individually set opening pressure on request

MATERIALS

AV619

Housing: Brass 2.0401, bright galvanized brass, 2.0401, stainless steel 1.4305 or 1.4404

Seal: CR, EPDM, FFKM, FPM, HNBR, NBR, natural silicone

AV919

Housing: Stainless steel 1.4571, anodised aluminium

Seal: CR, EPDM, FFKM, FPM, NBR, VMQ

SMALL AND LIGHTWEIGHT

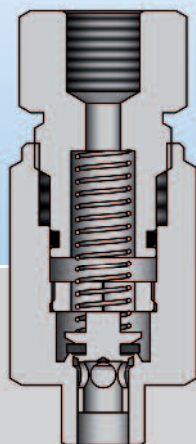

AV319

- High safety in mini format – the AV654 is the smallest WITT safety valve
- Also protects against lowest overpressures
- Very sensitive response with individual opening pressure in the range from 10 to 80 mbar / 0.14 to 1.14 psi
- Maximum blow-off volume of approx. 0.9 m³/h / 32 scfh for air
- Minimum weight and compact dimensions
- Ideal for applications in a closed space or with special weight requirements
- Installation irrespective of position
- TÜV certificate verifies the individually set opening pressure on request

MATERIALS

AV319

Housing: Brass, stainless steel 1.4305 or 1.4404 or 1.4571

Seal: CR, EPDM, FPM, Isolast, NBR

SPECIALIST IN HYDROGEN VEHICLES

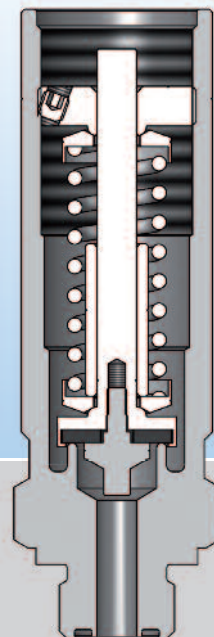

SV811L

- Specially developed for securing hydrogen-powered vehicles
- Protects hydrogen systems against hazardous overpressure in a wide spectrum from 4.5 to 45 bar / 65 to 652 psi
- Corresponds to regulation EC 79/2009 of the European Parliament
- Approved by the Kraftfahrt-Bundesamt (German Federal Motor Transport Authority) for use in vehicles
- Compact design
- Installation irrespective of the position
- Diverse connection options
- High-quality stainless steel for maximum resistance and endurance
- TÜV certificate verifies the individually set opening pressure on request











MATERIALS

SV811L

Housing: Stainless steel 1.4404

Seal: EPDM

OVERVIEW OF ALL MODELS

Material	Image	Model	Remarks	Technical information					Features			
				Opening pressure	Inlet-connection	Outlet-connection	With condensation outlet	Inlet filter (optional)	Manual ventilation	Manufactured and certified according to EN ISO 4126-1 AD 2000 bulletin A2 and VdTUV-bulletin 100	Single certification (Modul F)	Approval according to (EC) No. 79/2009
Brass		SV 805	CE-marked according to PED 97/23/EG CE0045	0.5 bar–45 bar 7 psi–652 psi	G 1/4–G 3/4 1/4"–3/4" NPT	M24 x 1	X		X	X		
		SV 805A	CE-marked according to PED 97/23/EG CE0045	0.5 bar–45 bar 7 psi–652 psi	G 1/4–G 3/4 1/4"–3/4" NPT	1/2" NPT	X	X	X	X		
Stainless steel		SV 805-ES	CE-marked according to PED 97/23/EG CE0045	0.5 bar–45 bar 7 psi–652 psi	G 1/4–G 3/4 1/4"–1/2" VCR 1/4"–3/4" NPT	M24 x 1	X		X	X		
		SV 805A-ES	CE-marked according to PED 97/23/EG CE0045	0.5 bar–45 bar 7 psi–652 psi	G 1/4–G 3/4 1/4"–1/2" VCR 1/4"–3/4" NPT	1/2" NPT	X	X	X	X		
Brass		AV 619		0.005 bar–< 0.5 bar 0.07 psi–7 psi	G 1/2 – G 1 1/2"–1" NPT	G 1/2 – G 1 1/2"–1" NPT		X			X	
Stainless steel		AV 619-ES		0.005 bar–< 0.5 bar 0.07 psi–7 psi	G 1/2 – G 1 1/2"–1" NPT	G 1/2 – G 1 1/2"–1" NPT		X			X	
Aluminium anodized		AV919		0.005 bar–< 0.5 bar 0.07 psi–7 psi	G 2 2" NPT	G 2 2" NPT		X			X	
Stainless steel		AV919-ES		0.005 bar–< 0.5 bar 0.07 psi–7 psi	G 2 2" NPT	G 2 2" NPT		X			X	
Brass		AV319		10 mbar–80 mbar 0.14 psi–1.14 psi	G 1/8	G 1/8					X	
Stainless steel		AV319-ES		10 mbar–80 mbar 0.14 psi–1.14 psi	G 1/8	G 1/8					X	
Stainless steel		SV811L	Approved by the Kraftfahrt-Bundesamt (German Federal Motor Transport Authority) for use in vehicles	4,5 bar–45 bar 65 psi–652 psi	9/16 – 18UNF G 1/4 – G 3/4 1/4"–3/4" NPT	M24 x 1				X	X	X

Other connections available on request

CERTIFIED ACCORDING
EN 720-2, ISO 5175, ISO 9001, PED, BAM, UL, TÜV



OUR PROMISE

- ▶ **High-quality
safety technology**
- ▶ **Very good
price/performance ratio**
- ▶ **Individual safety relief valves
and special solutions**
- ▶ **Decades long
WITT know-how**

▀ **OUR PRODUCT RANGE**

Gas Control Equipment

- Gas mixing systems
- Gas metering systems
- Gas analysers
- Leak detection systems
- Gas pressure vessels
- Engineering of customised systems

Gas Safety Equipment

- Flashback arrestors
- Non-return valves / check valves
- Quick couplers
- Safety relief valves
- Stainless steel devices
- Gas filters
- Pressure regulators
- Outlet points
- Lance holders
- Ball valves
- Automatic hose reels
- Test equipment
- Accessories
- Customised safety equipment

WITT-Gasetechnik GmbH & Co KG

Salinger Feld 4-8 • 58454 Witten
POB 2550 • 58415 Witten
Germany
Tel. +49 (0)2302 8901-0
Fax +49 (0)2302 8901-3
www.wittgas.com • witt@wittgas.com

WITT Gas Controls LP

380 Winkler Drive, STE 200
Alpharetta, GA. 30004
USA
Tel. +1 888 948 8427
Fax +1 877 948 8427
witt-usa@wittgas.com

WITT Gas Techniques Ltd.

212, Europa Boulevard Westbrook
Warrington, WA5 7TN
Great Britain
Tel. +44 (0)1925 234466
Fax +44 (0)1925 230055
witt-uk@wittgas.com

WITT POLSKA Sp. z o. o.

ul. Legnicka 55/UA5
54-203 Wroclaw
Polska
Tel. +48 (0)7135 22856
Fax +48 (0)7135 13113
witt-polska@wittgas.com

WITT FRANCE S.A.R.L.

131 Voie de Compiègne
91390 Morsang sur Orge
France
Tel. +33 (0)160 151779
Fax +33 (0)160 154782
witt-france@wittgas.com

WITT ITALIA Srl.

Via Giovanni XXIII, 18
24030 Solza (BG)
Italia
Tel. +39 035 4933273
Fax +39 035 4948098
witt-italia@wittgas.com

WITT Tecnología de Gas, S.L.

C/Simón Cabarga Nº 2a – Bajo
39005 Santander
España
Tel. +34 942 835142
Fax +34 942 835143
witt-espana@wittgas.com

GUSTUS & PARTNER GmbH

Installation – Service – Wartung
Alt Salbke 6-10, Geb. 59
39122 Magdeburg
Germany
Tel. +49 (0)391 4015246
Fax +49 (0)391 4013296
gustus@wittgas.com