



# PV Accessories Manual

光伏零配件手册

# Hand in Hand

## 共同携手

为“绿色能源”和“世界环保”献出一份力，  
为人类发展创造美好的明天献出一份力。

We make every effort to “Green Energy” and “World Environmental Protection”  
and dedicate to create a better future for human beings.



# NewSun

# Profile

## 公司概况

世界人口的增加及全球经济的增长对能源需求越来越大,人类赖以生存的地球正在面临日益严峻的能源危机。太阳能作为零排放、零消耗、清洁、安全、环保的可再生能源,具有极大的潜能。

新金阳光电科技有限公司竭力为节能减排、低碳环保,建设和不断推进绿色可再生能源的发展作出应有的贡献。公司集设计、研发、生产、销售为一体的现代化管理企业。产品包含光伏系统连接(连接器、接线盒、光伏线缆、安装配件、控制器、配电箱&汇流箱、逆变器&微逆变器、支架...);系统保护(接地保护、二极管、保险丝、断路器..)及系统优化等,符合TUV、UL、SAA、CE等相关认证标准。并涵盖光伏系统应用、太阳能路灯、风光互补路灯等领域。以及光伏系统集成解决方案(EPC)。

“专注品质、开拓创新、诚信务实、合作共赢、服务社会”是新金阳人始终如一追求。为光伏零组件商,系统安装商提供优质、经济、安全、可靠的技术和具有竞争优势的产品是新金阳永恒的方针。我们不断超越,共同携手为“绿色能源”和“世界环保”献出一份力,为人类发展创造美好的明天献出一份力。

NewSun PV Technology Co., Ltd strives to make contribution to energy saving, low carbon emission, environmental protection, and will continuously push forward to the development of green renewable energy. The company integrates design, development, production, sales as the modern management of enterprises. Our product line includes PV Solar System (connectors, junction box, PV cable, installation accessories, controller, distribution box & combiner box, inverter & micro-inverter and bracket, etc.), Protection System (earth-fault protection, diode connector, fuse connector, circuit breaker, etc.) and System Optimization. Our products meet the standards of TUV, UL, SAA, CE certification. Also the field covers the PV system

application, solar street light, solar hybrid street lighting, etc. and Energy Performance Contracting(EPC).

“Exploration and innovation, quality, honesty and pragmatism, win-win cooperation, social responsibility” is the consistent spirit for NSPV people. Offer high quality, economical cost, safe solution and reliable technology with optimization in energy conservation and environmental protection is the solid goal for photovoltaic component manufacturers and system installers include NSPV. We will continuously make contribution to “Green energy” and “World environmental protection” for establishing humans better tomorrow.

# Certificate 认证



# Catalogue 目录

 <p><b>DC连接器系列</b> DC CONNECTOR</p>	<b>光伏4.0线端连接器 1500V DC</b> PV 4.0 CABLE CONNECTOR 1500V DC	01	<b>光伏4.0分支连接器 1500V DC</b> PV 4.0 BRANCH CONNECTOR 1500V DC	02	
	<b>光伏4.0保险丝连接器 1500V DC</b> PV 4.0 FUSE CONNECTOR 1500V DC	03	<b>光伏4.0 面板式保险丝连接器 1500V DC</b> PV 4.0 PANEL FUSE Connector 1500V DC	04	
	<b>光伏4.0 2转1分支保险丝连接器 1500V DC</b> PV 4.0 2 TO 1 FUSE CONNECTOR 1500V DC	05	<b>光伏4.0线端连接器 1000V DC</b> PV 4.0 CABLE CONNECTOR 1000V DC	06	
	<b>光伏4.0二极管连接器 1000V DC</b> PV 4.0 DIODE CONNECTOR 1000V DC	07	<b>光伏3.0连接器 1000V DC</b> PV 3.0 CONNECTOR 1000V DC	08	
 <p><b>AC连接器系列</b></p>	<b>光伏AC连接器 II</b> PV AC CONNECTOR II	09	<b>光伏AC连接器 I</b> PV AC CONNECTOR I	10	
 <p><b>电线连接类</b> SOLAR CABLE</p>	<b>光伏直流电线 1000V DC</b> SOLAR DC CABLE 1000V DC	11	<b>光伏直流电线 1500V DC</b> SOLAR DC CABLE 1500V DC	12	
	<b>交流电缆 (3芯)</b> AC CABLE (3 CORES)	13	<b>2C+E电缆</b> 2C+ E CABLE	14	
	<b>光伏4.0线束带保险丝连接器</b> PV 4.0 CABLE ASSEMBLIES WITH FUSE	16	<b>光伏线束 I</b> PV CABLE ASSEMBLIES I	17	
	<b>光伏线束 II</b> PV CABLE ASSEMBLIES II	18	<b>4进1出绝缘穿刺线夹</b> 4 IN 1 INSULATION PIERCING CONNECTOR	20	
 <p><b>光伏配件系列</b></p>	<b>配件系列</b> ACCESSORIES SERIES	21			
 <p><b>光伏接线盒</b> PV JUNCTION BOX</p>	<b>光伏4线接线盒+</b> PV 4 RAILS JUNCTION BOX	25	<b>光伏小型接线盒</b> PV MINI JUNCTION BOX	25	
	<b>PV-NEHP01接线盒</b> PV-NEHP01 JUNCTION BOX	26	<b>薄膜专用接线盒</b> BIPV JUNCTION BOX	27	
	<b>薄膜专用(单体)接线盒</b> BIPV SINGLE JUNCTION BOX	27	<b>EC1+EC2边接线盒</b> EC1+EC2 EDGE CONNECTOR	28	
	<b>EC03边接线盒</b> EC03 EDGE CONNECTOR	28			
 <p><b>光伏汇流箱</b> PV COMBINER BOX</p>	<b>汇流箱</b> COMBINER BOX	30	<b>DC1000V光伏保险丝座</b> 1000VDC DIN RAIL FUSE HOLDER	31	
	<b>光伏发电保护用熔断器DC1000V</b> SOLAR FUSE DC1000V	31	<b>DC1500V光伏保险丝座</b> 1500VDC DIN RAIL FUSE HOLDER	32	
	<b>光伏发电保护用熔断器DC1500V</b> SOLAR FUSE DC1500V	32	<b>交流小型断路器</b> AC MINIATURE CIRCUIT BREAKER	33	
	<b>直流小型断路器</b> DC MINIATURE CIRCUIT BREAKER	33	<b>小型断路器防水盒</b> MCB ENCLOSURE BOX	33	
	<b>小型断路器锁</b> MCB LOCKOUT	33	<b>直流塑壳断路器</b> DC MCCB	34	
	<b>光伏防雷电涌保护器</b> PV SURGE PROTECTIVE DEVICE (SPD)	34	<b>TB接线座 2-20P</b> TB TERMINAL BLOCK 2-20P	34	
	<b>NSI01-32P光伏隔离开关</b> NSI01-32P SOLAR ISOLATOR SWITCH	35	<b>AC开关</b> AC SWITCH	36	
	<b>DC开关</b> DC SWITCH	36			
	 <p><b>光伏安装工具</b></p>	<b>光伏安装工具</b> PV INSTALLATION TOOLS	37	<b>光伏警示牌</b> PV SOLAR LABEL	38

# 光伏4.0线端连接器1500V DC

## PV 4.0 CABLE CONNECTOR 1500V DC

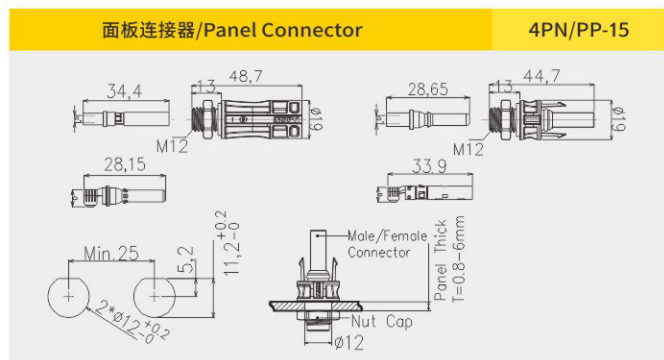
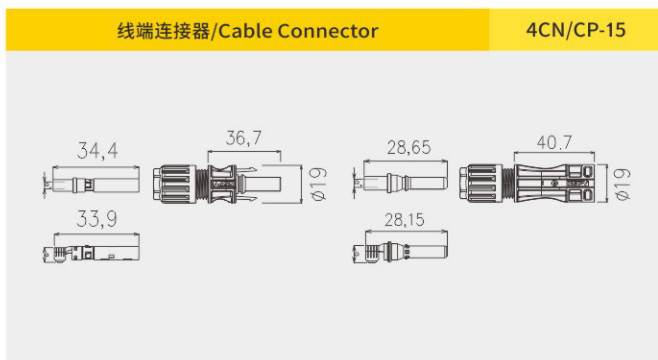

### 产品规格 Product Specifications

绝缘材料 Insulation material	PPE/PA	阻燃等级 Flame class	UL94-V0
额定电流 Rated current	见下表/See table below	温度上限 Upper limiting temperature	110°C(IEC)
额定电压 Rated voltage	1500V DC	拔出力/插入力 Withdrawal force/Insertion force	≥50N/≤50N
测试电压 Test voltage	8KV(50Hz,1min)	过压等级 Overvoltage category/Pollution degree	CATIII/2
接触电阻 Contact resistance	≤ 0.25 mΩ	环境温度范围 Ambient temperature range	-40°C...+85°C(IEC)
导体材料 Contact material	铜,镀锡/Copper,Tin plated	适配电线规格 Suitable cable cross sections	2.5-16mm <sup>2</sup> /14-6AWG
防护等级 Degree of protection	IP68	连接方式 Connection mode	压接/Crimp connection
安全等级 Safety degree	II	产品颜色 Product color	黑色/Black

4.0 线端连接器 4.0 Cable Connector	4.0 板端连接器 4.0 Panel Connector	电流 Current	a	a'	适配电线规格 Cable Size
料号 Part No.		Amps			
4CN/CP25	4PP/PN25	35	4.8	Ø 2.1	2.5mm <sup>2</sup> & 14AWG
4CN/CP40	4PP/PN40	35	5.8	Ø 2.8	4.0mm <sup>2</sup> & 12AWG
4CN/CP60	4PP/PN60	35	5.8	Ø 3.4	6.0mm <sup>2</sup> & 10AWG
4CN/CP100		60	7.9	Ø 4.5	10.0mm <sup>2</sup> & 8AWG
4CN/CP160		65		Ø 5.6	16.0mm <sup>2</sup> & 6AWG

# 光伏4.0分支连接器1500V DC

## PV 4.0 BRANCH CONNECTOR 1500V DC



2转1连接器/2to1 Branch connector 4BP/BN-15

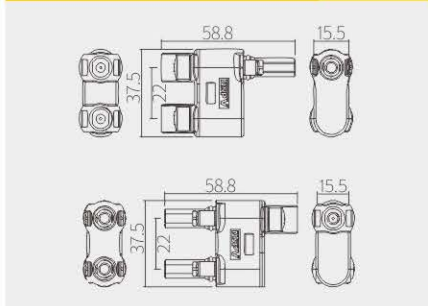

3转1连接器/3to1 Branch connector 31BN/BP-15

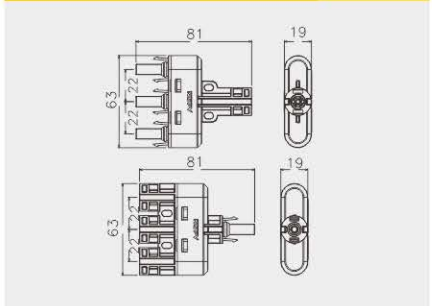

4转1连接器/4to1 Branch connector 4B4100/01

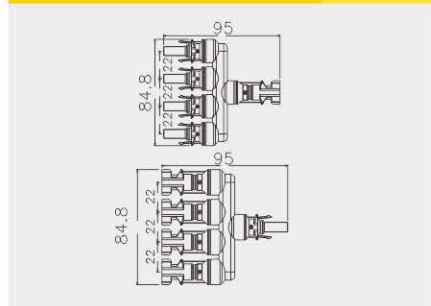

### 产品规格 Product Specifications

绝缘材料 Insulation material	PPE	安全等级 Safety degree	II
额定电压 Rated voltage	1500V DC	阻燃等级 Flame class	UL94-V0
额定电流 Rated current	35A	插入力 Insertion force	≤50N
测试电压 Test voltage	8kV(50Hz,1min)	拔出力 Withdrawal force	≥50N
连接器接触电阻 Contact resistance	≤0.25 mΩ	环境温度范围 Ambient temperature range	-40°C...+85°C(IEC)
金属导体材料 Contact material	铜,镀锡/Copper,Tin plated	温度上限 Upper limiting temperature	110°C(IEC)
防护等级 Degree of protection	IP68	产品颜色 Product color	黑色/Black
过压等级 Overvoltage category/Pollution degree	CATIII/2	连接方式 Connection mode	直插/Connect straightly



# 光伏4.0保险丝连接器1500V DC

PV 4.0 FUSE CONNECTOR 1500V DC



4F0-15



4F3-15



4F1-15



4F2-15

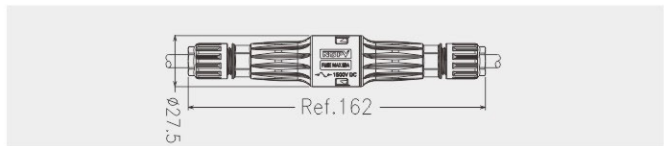
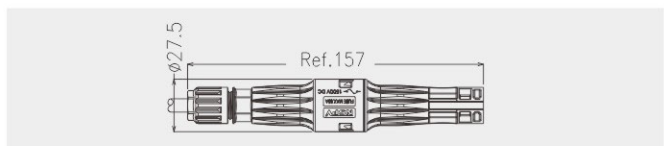
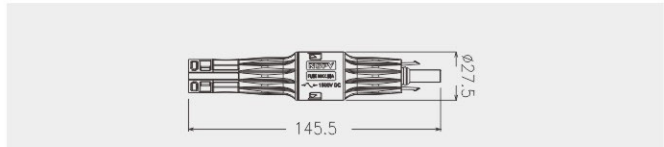

## 产品规格 Product Specifications

绝缘材料 Insulation material	PPE/PA
额定电流 (不含保险丝) Rated current (Without fuse)	50A
额定电压 Rated voltage	1500VDC
最大的测试电压(含保险丝) Maximum voltage (With fuse)	1575V
连接器接触电阻 Contact resistance	≤ 0.25 mΩ
金属导体材料 Contact material	铜,镀锡 Copper,Tin plated
防护等级 Degree of protection	IP68
产品颜色 Product color	黑色/Black
保险丝规格 Fuse Specification	1A,2A,3A,3.5A,4A,5A,6A,8A,10A,12A,15A, 16A,20A,25A,30A,32A,35A,40A,45A,50A
阻燃等级 Flame class	UL94-V0
安全等级 Safety degree	II
符合标准 Regulatory approval	TUV,CE
环境温度范围 Ambient temperature range	-40°C...+85°C(IEC)
适配电线规格 Suitable cable cross sections	2.5-10mm <sup>2</sup> /14-8AWG
适配保险丝尺寸 (mm) Suitable for fuse size(mm)	10*85 or 10/14*85
温度上限 Upper limiting temperature	110°C(IEC)

## 便捷快速

### 更换内部保险丝

Replace Inline Fuse



## 节省成本 维护简单

外观设计专利产品  
Patent for appearance design



# 光伏4.0 面板式保险丝连接器1500V DC

PV 4.0 PANEL FUSE Connector 1500V DC

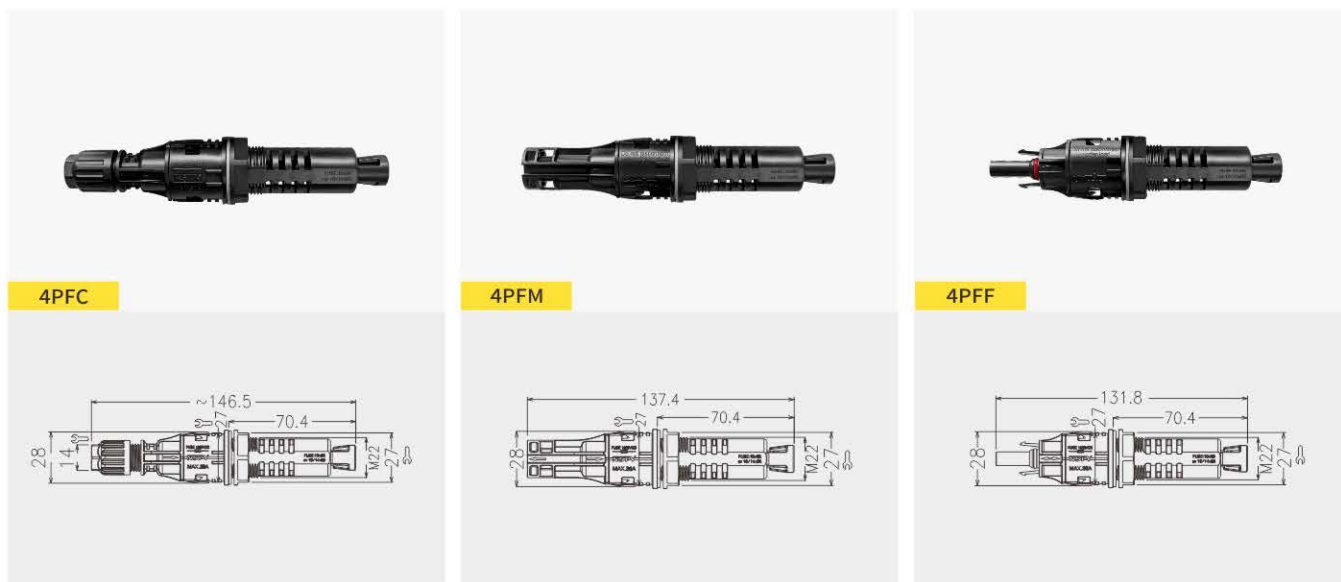

## 产品规格 Product Specifications

绝缘材料 Insulation material	PPE/PA
额定电流(不含保险丝) Rated current (Without fuse)	50A
额定电压 Rated voltage	1500VDC
最大的测试电压(含保险丝) Maximum voltage (With fuse)	1575V
连接器接触电阻 Contact resistance	≤ 0.25 mΩ
金属导体材料 Contact material	铜, 镀锡 Copper, Tin plated
防护等级 Degree of protection	IP68
产品颜色 Product color	黑色/Black
保险丝规格 Fuse Specification	1A, 2A, 3A, 3.5A, 4A, 5A, 6A, 8A, 10A, 12A, 15A, 16A, 20A, 25A, 30A, 32A, 35A, 40A, 45A, 50A
阻燃等级 Flame class	UL94-V0
安全等级 Safety degree	II
符合标准 Regulatory approval	TUV, CE
环境温度范围 Ambient temperature range	-40°C...+85°C (IEC)
适配电线规格 Suitable cable cross sections	2.5-10mm <sup>2</sup> /14-8AWG
适配保险丝尺寸(mm) Suitable for fuse size(mm)	10*85 or 10/14*85
温度上限 Upper limiting temperature	110°C (IEC)

## 面板孔位尺寸 Panel Hole Size

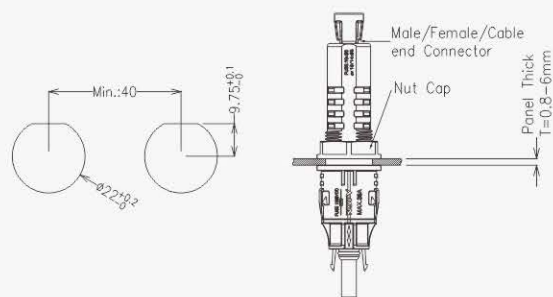

**便捷快速**  
更换内部保险丝

Replace Inline Fuse

外置型 | 热量低  
空间小 | 省成本

External type | low heat  
Small space | save cost

# 光伏4.0 2转1分支保险丝连接器 1500V DC

## PV 4.0 2 TO 1 FUSE CONNECTOR 1500V DC

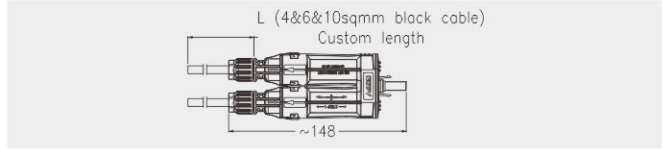
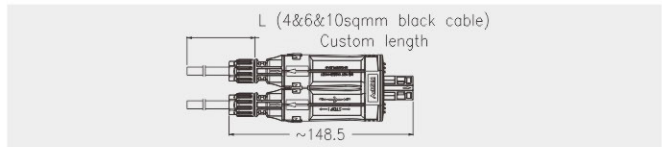
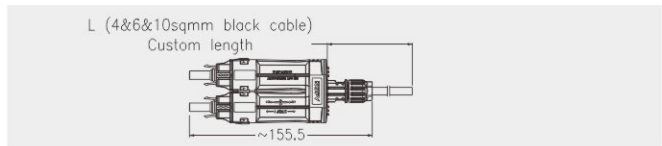
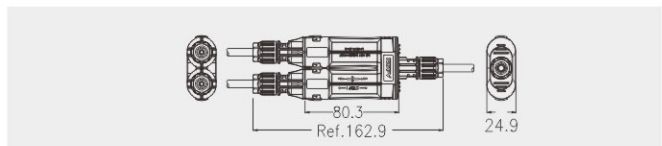
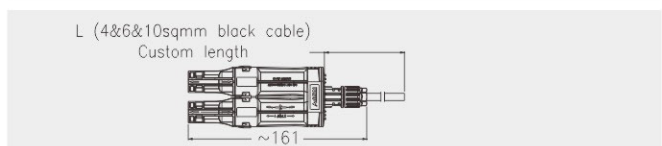
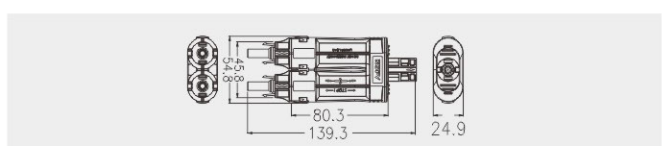
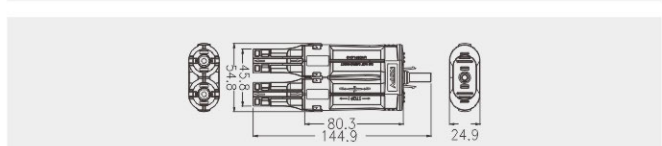
**4FBCF\*\* -15**

**4FBCM\*\* -15**

**4FBFC\*\* -15**

**4FBCC\*\* -15**

**4FBMC\*\* -15**

**4FBFM\*\* -15**

**4FBMF\*\* -15**

### 产品规格 Product Specifications

绝缘材料 Insulation material	PPE/PA
额定电压 Rated voltage	1500VDC
额定电流 (不含保险丝) Rated current (Without fuse)	Max. Input:30A Max. Output:60A
最大的测试电压 Maximum voltage	8kV
连接器接触电阻 Contact resistance	≤ 0.25 mΩ
金属导体材料 Contact material	铜, 镀锡 Copper, Tin plated
防护等级 Degree of protection	IP68
产品颜色 Product color	黑色/Black

保险丝规格 Fuse Specification	1A,2A,3A,3.5A,4A,5A,6A,8A,10A,12A,15A, 16A,20A,25A,30A,32A,35A,40A,45A,50A
阻燃等级 Flame class	UL94-V0
安全等级 Safety degree	II
符合标准 Regulatory approval	TUV/CE (EN60269)
环境温度范围 Ambient temperature range	-40°C...+85°C (IEC)
适配保险丝尺寸 (mm) Suitable for fuse size (mm)	10*85 or 10/14*85
适配电线规格 Suitable cable cross sections	2.5-10mm <sup>2</sup> /14-8AWG
温度上限 Upper limiting temperature	110°C (IEC)

# 光伏4.0线端连接器1000V DC

## PV 4.0 CABLE CONNECTOR 1000V DC

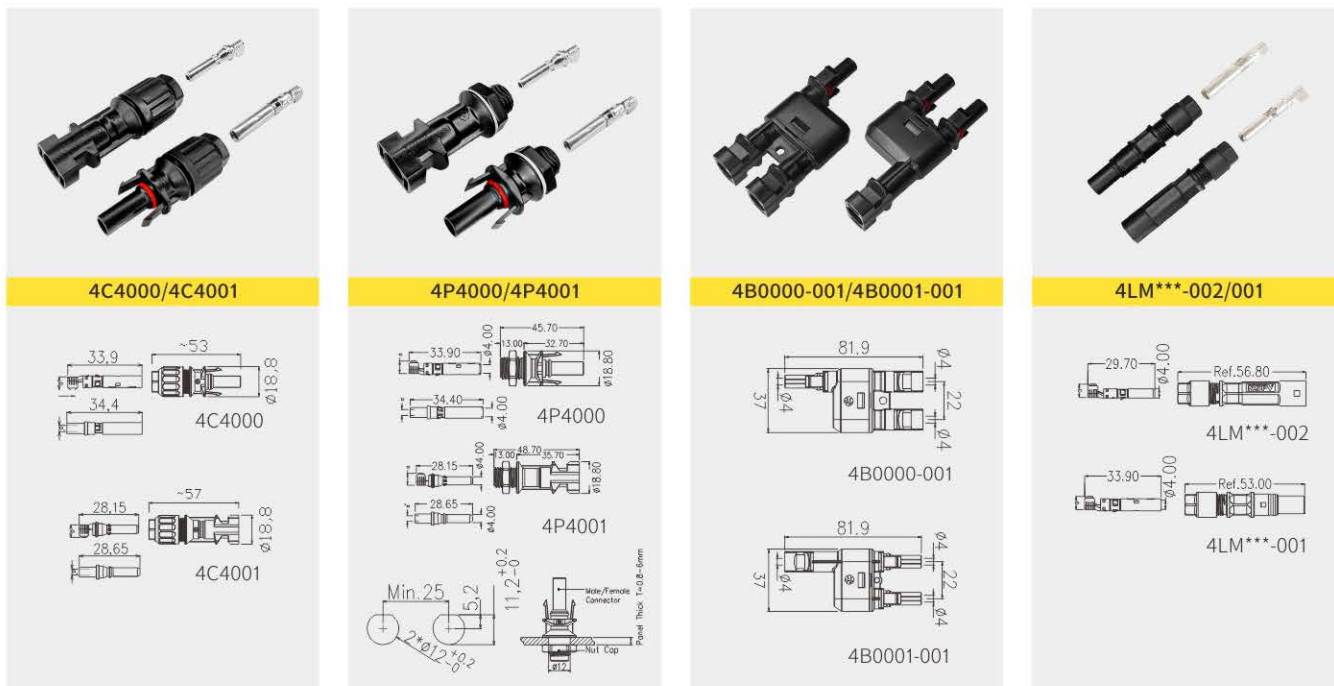

### 产品规格 Product Specifications

绝缘材料 Insulation material	PPE/PA	阻燃等级 Flame class	UL94-V0
额定电流 Rated current	30A	温度上限 Upper limiting temperature	110°C (IEC)
额定电压 Rated voltage	1000V DC	产品认证 Certificate	TUV
测试电压 Test voltage	6kV(50Hz, 1min)	连接方式 Connection mode	压接/Crimp connection
接触电阻 Contact resistance	≤ 0.25 mΩ	环境温度范围 Ambient temperature range	-40°C...+85°C(IEC)
导体材料 Contact material	铜,镀锡 Copper, Tin plated	适配电线规格 Suitable cable cross sections	2.5~6mm <sup>2</sup> /14~10AWG
防护等级 Degree of protection	IP67	拔出力/插入力 Withdrawal force/Insertion force	≥50N/≤50N
安全等级 Safety degree	II	产品颜色 Product color	黑色/Black

### 连接器防尘盖 Connector End Cap

<p>Male Female</p>	<p>L03001</p>	料号 Part Number	L03001/L03002
<p>Male Female</p>	<p>L03002</p>	颜色 Color	Black
		绝缘材料 Insulation material	EPDM
		安全等级 Safety degree	II
		燃烧等级 Flame class	UL94-V0
		环境温度范围 Ambient temperature range	-40°C until +90°C
		合适电缆连接器 Suitable cable connector	PV4.0 Connector Compatible MC4 Connector

## 光伏4.0二极管连接器1000V DC

PV 4.0 DIODE CONNECTOR 1000V DC

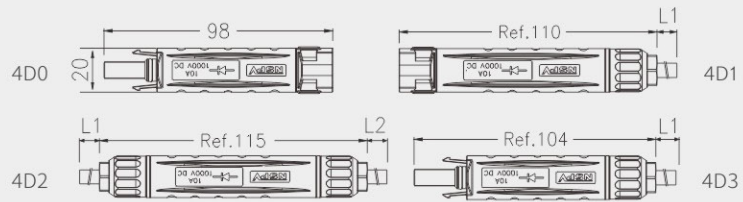

### 产品规格 Product Specifications

绝缘材料 Insulation material	PPE/PA	安全等级 Safety degree	II
额定电压 Rated voltage	1000VDC	阻燃等级 Flame class	UL94-V0
额定电流(含二极管) Rated current (With Diode)	10A (Diode Rated Current 15A)	插入力/拔出力 Insertion force/Withdrawal force	≤50N/≥50N
额定电流(不含二极管) Rated current (Without diode)	30A	过压等级 Overvoltage category/Pollution degree	CATIII/2
连接器接触电阻 Contact resistance	≤ 0.25 mΩ	环境温度范围 Ambient temperature range	-40°C...+85°C(IEC)
测试电压 Test voltage	6kV(50Hz, Imin)	连接方式 Connection mode	压接 Crimp connection
金属导体材料 Contact material	铜, 镀锡 Copper, Tin plated	适配电线规格 Suitable cable cross sections	2.5~6mm <sup>2</sup> /14~10AWG
防护等级 Degree of protection	IP67	温度上限 Upper limiting temperature	110°C(IEC)

## 光伏4.0保险丝连接器1000V DC

PV 4.0 FUSE CONNECTOR 1000V DC

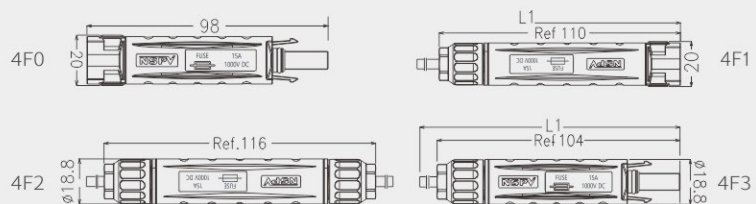

### 产品规格 Product Specifications

绝缘材料 Insulation material	PPE/PA	安全等级 Safety degree	II
额定电压 Rated voltage	1000VDC	阻燃等级 Flame class	UL94-V0
额定电流 Rated current	30A	插入力/拔出力 Insertion force/Withdrawal force	≤50N/≥50N
额定电流(含保险丝) Rated current (With fuse)	1A, 2A, 3.5A, 4A, 5A, 8A, 10A, 12A, 15A, 20A, 25A, 30A	过压等级 Overvoltage category/Pollution degree	CATIII/2
测试电压 Test voltage	6kV(50Hz, Imin)	环境温度范围 Ambient temperature range	-40°C...+85°C(IEC)
连接器接触电阻 Contact resistance	≤ 0.25 mΩ	连接方式 Connection mode	压接 Crimp connection
金属导体材料 Contact material	铜, 镀锡 Copper, Tin plated	适配电线规格 Suitable cable cross sections	2.5~6mm <sup>2</sup> /14~10AWG
防护等级 Degree of protection	IP67	温度上限 Upper limiting temperature	110°C(IEC)

# 光伏3.0连接器1000V DC

## PV 3.0 CONNECTOR 1000V DC



2转1连接器/2to1 Branch connector 3B0000/01

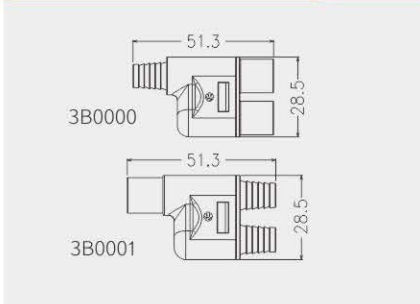

线端连接器/Cable connector 3C4000/01

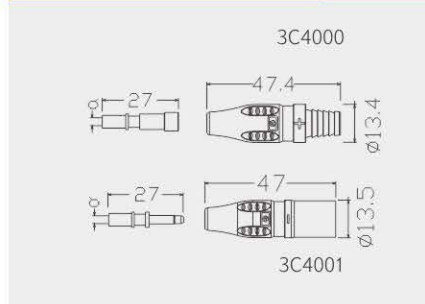

面板连接器/Panel connector 3P4000/01

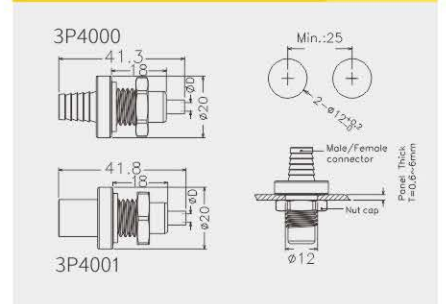

### 产品规格 Product Specifications

绝缘材料 Insulation material	PPE/TPV/PA	安全等级 Safety degree	II
额定电压 Rated voltage	1000V DC	阻燃等级 Flame class	UL94-V0
测试电压 Test voltage	6KV(50Hz,1min)	插入力 Insertion force	≤50N
额定电流 Rated current	30A	拔出力 Withdrawal force	≥50N
连接器接触电阻 Contact resistance	≤ 0.25 mΩ	环境温度范围 Ambient temperature range	-40°C...+85°C(IEC)
金属导体材料 Contact material	铜,镀锡 Copper,Tin plated	温度上限 Upper limiting temperature	110°C(IEC)
防护等级 Degree of protection	IP67	适配电线规格 Suitable cable cross sections	2.5-6mm <sup>2</sup> /14-10AWG
过压等级 Overvoltage category/Pollution degree	CATIII/2	端子尺寸 Pin dimensions	Φ3.0



# 光伏AC连接器 II

## PV AC CONNECTOR II

此护套有两种可选



3PCF

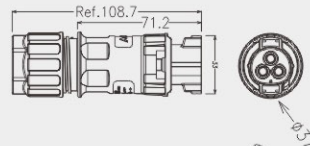

3PCM

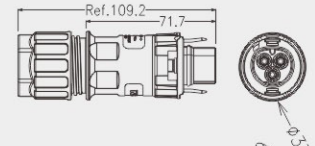

3PPF

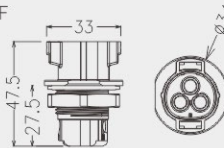

3PPM

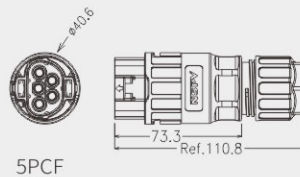
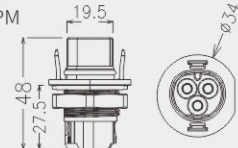

5PCF

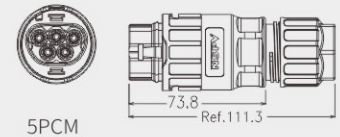

5PCM

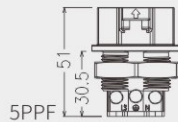

5PPF

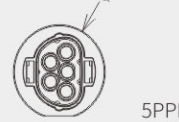

5PPM

产品规格 Product Specifications	2P/3P	4P/5P
绝缘材料 Insulation material	PPE/PC/PA	PPE/PC/PA
额定电压 Rated voltage	500V AC	500V AC
额定电流 Rated current	Max.50A(10sqmm)	Max.50A(10sqmm)
测试电压 Test voltage	4KV	4KV
连接器接触电阻 Contact resistance	≤ 0.25 mΩ	≤ 0.25 mΩ
金属导体材料 Contact material	铜,镀银 Copper,silver plated	铜,镀银 Copper,silver plated
防护等级 Degree of protection	IP68	IP68
产品颜色 Product color	黑色/Black	黑色/Black
安全等级 Safety degree	II	II
阻燃等级 Flame class	UL94-V0	UL94-V0
绝缘电阻 Insulation resistance	≥1000 MΩ	≥1000 MΩ
电线最大外径 Suitable cable OD Max.	Φ21mm	Φ21mm
环境温度范围 Ambient temperature range	-40°C...+85°C(IEC)	-40°C...+85°C(IEC)
连接方式 Connection mode	锁/铆接方式 Screw/crimping connection	锁/铆接方式 Screw/crimping connection
连接端子的直径及数量 Diameter and numbers of contact pins	Ø4.0x2/3	Ø4.0x4/5
适配电线规格 Suitable cable cross sections	2.5~10mm <sup>2</sup> /14~8AWG	2.5~10mm <sup>2</sup> /14~8AWG

# 光伏AC连接器 I

## PV AC CONNECTOR I



2芯/3芯 2C/3C

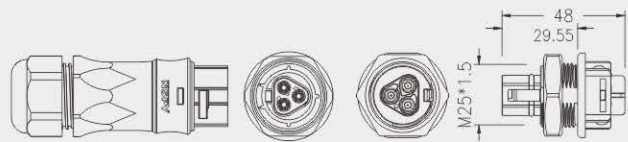

此护套有长中短三款 3PCF1-6 3PCM1-6 3PPM1-6



4芯/5芯 4C/5C



此护套有长中短三款 5PCF1-6 5PCM1-6 5PPM1-6

产品规格 Product Specifications	2C/3C	4C/5C
绝缘材料 Insulation material	PPE/PC/PA	PPE/PC/PA
额定电压 Rated voltage	500V AC	500V AC
额定电流 Rated current	Max.35A(6sqmm)	Max.40A(6sqmm)
测试电压 Test voltage	4KV	4KV
连接器接触电阻 Contact resistance	≤ 0.25 mΩ	≤ 0.25 mΩ
金属导体材料 Contact material	铜,镀银 Copper,silver plated	铜,镀银 Copper,silver plated
防护等级 Degree of protection	IP67	IP67
产品颜色 Product color	黑色/Black	黑色/Black
安全等级 Safety degree	II	II
阻燃等级 Flame class	UL94-V0	UL94-V0
绝缘电阻 Insulation resistance	≥1000 MΩ	≥1000 MΩ
电线最大外径 Suitable cable OD Max.	Φ21mm	Φ21mm
环境温度范围 Ambient temperature range	-40°C...+85°C(IEC)	-40°C...+85°C(IEC)
连接方式 Connection mode	锁/铆接方式 Screw/crimping connection	锁/铆接方式 Screw/crimping connection
连接端子的直径及数量 Diameter and numbers of contact pins	Ø2.6x2/3	Ø2.6x4/5
适配电线规格 Suitable cable cross sections	2.5~6mm <sup>2</sup> /14~10AWG	2.5~6mm <sup>2</sup> /14~10AWG

# 光伏直流电线1000V DC

## SOLAR DC CABLE 1000V DC

- XLPE flame retardant material  
采用XLPE阻燃材料
- Tinned Oxygen-free Copper Wire  
镀锡无氧铜丝 真材实料
- Even insulation thickness, low eccentricity  
绝缘厚度均匀 低偏心率
- UV resistant and high temperature resistant  
抗紫外线耐高温
- Certified by TUV  
通过TUV认证



### 产品参数 Product parameters

导体材料 Conductor material	镀锡退火软铜绞线 Soft annealed stranded tin-plated copper
绝缘材料 Insulation material	交联聚乙烯 Electron beam cross-linked material(XLPE)
护套材质 Jacket material	交联聚乙烯 Electron beam cross-linked material(XLPE)
参考标准 Applicable Standard	2PFG 1169/08.2007
印字标识 Identification Mark	TüV 2 Pfg 1169 PV1-F 1X**mm <sup>2</sup> NSPV NewSun PV Technology Co.,Ltd
成品电缆耐压 Voltage test of finished cable	AC 6.5KV 5min, or DC 1.5KV 5min 不击穿 No break

### 产品规格 Specifications

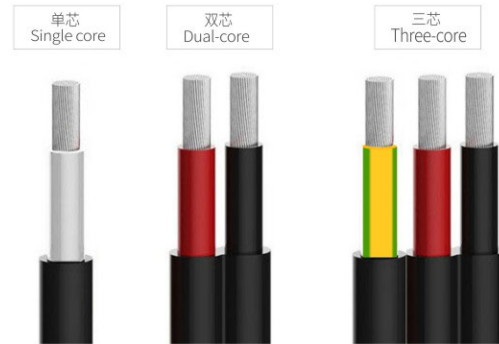

导体Conductor		护套Jacket		导体电阻 Conductor Resistance
面积 Area.(mm <sup>2</sup> )	绞线外径 Stranded OD(mm)	外径 Diameter(mm)	颜色 Color	Max. (Ω/KM) (at 20°C)
2.5	1.93	5.40±0.2	Black/red	8.21
4	2.46	5.50±0.2		5.09
6	3.01	6.10±0.2		3.39
10	4	7.20±0.2		1.95
额定电压/Rated voltage		V	1000VDC	
工作环境/Ambient temperature		°C	-40~+90	
最大导体温度/Max.conductor temperature		°C	+120	
短路电流温度/Short circuit temperature		°C	+200(at the conductor max.5sec)	



# 光伏直流电线1500V DC

## SOLAR DC CABLE 1500V DC

- Low smoke and halogen free with XLPE flame retardant material  
采用XLPE阻燃材料 低烟无卤
- Tinned Oxygen-free Copper Wire  
镀锡无氧铜丝 真材实料
- Even insulation thickness, low eccentricity  
绝缘厚度均匀 低偏心率
- UV resistant and high temperature resistant  
抗紫外线耐高温
- Certified by TUV  
通过TUV认证



### 产品参数 Product parameters

导体材料 Conductor material	镀锡退火软铜绞线 Soft annealed stranded tin-plated copper
绝缘材料 Insulation material	交联聚烯烃 Electron beam cross-linked material (XLPE)
护套材质 Jacket material	交联聚烯烃 Electron beam cross-linked material (XLPE)
参考标准 Applicable Standard	62930 IEC 131
印字标识 Identification Mark	TUV 62930 IEC 131 HALOGEN FREE LOW SMOKE 1X**mm <sup>2</sup> 1500VDC NSPV NewSun PV Technology Co.,Ltd
成品电缆耐压 Voltage test of finished cable	AC 6.5KV 5min, or DC 1.5KV 5min 不击穿 No break

### 产品规格 Specifications



导体Conductor		护套Jacket		导体电阻 Conductor Resistance
面积 Area.(mm <sup>2</sup> )	绞线外径 Stranded OD(mm)	外径 Diameter(mm)	颜色 Color	Max. (Ω/KM) (at 20°C)
2.5	1.93	5.2±0.2	Black/red	8.21
4	2.46	5.5±0.2		5.09
6	3.01	6.1±0.2		3.39
10	4	7.8±0.2		1.95
额定电压/Rated voltage		V	1500VDC	
工作环境/Ambient temperature		°C	-40~+90	
最大导体温度/Max.conductor temperature		°C	+120	
短路电流温度/Short circuit temperature		°C	+200(at the conductor max.5sec)	

# 交流电缆 (3芯)

## AC CABLE (3 CORES)

- Flame retardant material  
阻燃防火材料
- Oxygen free copper with high purity  
高纯度无氧铜丝 真材实料
- Even insulation thickness, low eccentricity  
绝缘厚度均匀 低偏心率
- UV resistant and high temperature resistant  
抗紫外线耐高温
- Various specifications  
多种规格可选

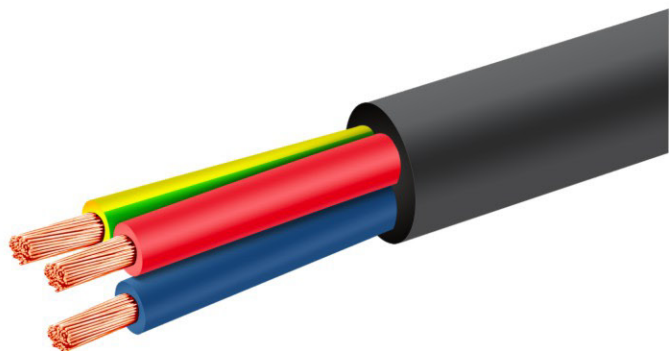

### 产品规格 Product Specifications

导体材料 Conductor material	铜/CU
绝缘材料 Insulation material	EPDM
护套材质 Jacket material	PVC
额定电压 Rated Voltage	300/500V
整体尺寸 (毫米) Overall dimension (mm)	6.4~15.5
导体尺寸 (毫米) Conductor dimension (mm)	1.13~3.10



项目 Item		单位 Unit	详细内容 Details			
产品名称 Product's Name			RV0.75mm	RV1.5mm <sup>2</sup>	RV2.5mm <sup>2</sup>	RV4.0mm <sup>2</sup>
产品规格 Specification			0.75mm <sup>2</sup>	1.5mm <sup>2</sup>	2.5mm <sup>2</sup>	4.0mm <sup>2</sup>
导体 Conductor	材质 Material		CU	CU	CU	CU
	材质 Material		PVC	PVC	PVC	PVC
护套 Jacket	外径 O.D.	mm	2.4	3.1	3.7	4.5
	颜色 Color		Black	Black	Black	Black
额定电压 Rated Voltage		V	300/500	300/500	300/500	300/500
20°C导体最大电阻 Max. Conductor Resistance at 20°C		Ω/km	26	13.3	7.98	5.09

## 2C+E电缆

### 2C+ E CABLE

- Flame retardant material  
阻燃防火材料
- Oxygen free copper with high purity  
高纯度无氧铜丝 真材实料
- Even insulation thickness, low eccentricity  
绝缘厚度均匀 低偏心率
- UV resistant and high temperature resistant  
抗紫外线耐高温
- Various specifications  
多种规格可选

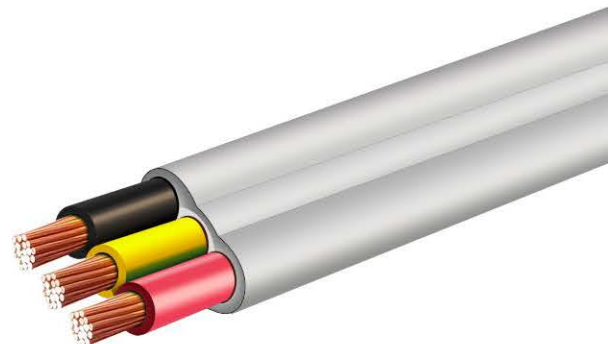

#### 产品规格 Product Specifications

导体材料 Conductor material	铜/CU
绝缘材料 Insulation material	PVC,V-90
护套材质 Jacket material	PVC,5V-90
额定电压 Rated Voltage	450/750
额定温度 Rated Temperature	90°C
20°C导体最大电阻 Max. Conductor Resistance at 20°C	≤7.41 Ω/km

#### 产品结构示意图 Construction Drawing

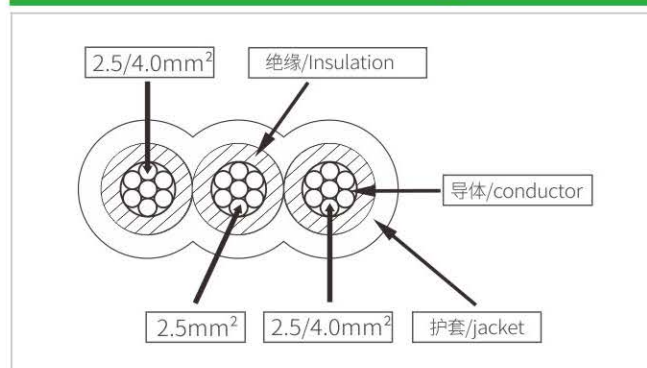

## 太阳能接地电缆

### SOLAR EARTHING CABLE

- High temperature resistance of PVC flame retardant material  
采用PVC阻燃材料 耐高温
- Oxygen free copper with high purity  
高纯度无氧铜丝 真实材料
- Even insulation thickness, low eccentricity  
绝缘厚度均匀 低偏心率
- Anti-aging, long life  
抗老化寿命长



#### 产品规格 Product Specifications

产品名称 Product name	太阳能接地电缆 Solar Earthing cable
产品规格 Specification	4mm <sup>2</sup> x1C
应用范围 Scope of application	电力/Electricity
产品定制 Product customization	支持/Support

#### 产品结构示意图 Construction Drawing

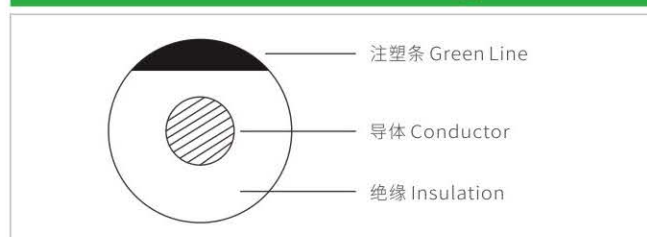

SOLAR CABLE HARNESS WITH FUSE

太阳能光伏保险丝线束

# 为您的光伏系统 保驾护航

Protect Your PV System

T型、Y型、十字形等  
各种类型可定制

Customizable

便捷更换保险丝  
节省成本易维护

Fast to replace inline fuse

Cost-saving and handy to maintain



抗紫外线  
UV resistant



耐高低温  
Heat-resistant



阻燃防火  
Fire resistant



防水IP68  
Waterproof IP68



15 NSPV

# 光伏4.0线束带保险丝连接器

## PV 4.0 CABLE ASSEMBLIES WITH FUSE

- Customize to meet your needs  
按照要求定制线束
- Convenient to replace fuse  
便捷更换保险丝
- Waterproof IP68 rating  
防水等级达到IP68
- Protect your PV system with fast fusing  
快速熔断, 保护您的光伏系统
- Imported material, flame retardant and anti-UV  
进口材质, 阻燃抗UV, 使用更安全

### 产品规格 Product Specifications

绝缘材料 Insulation material	PPE/TPE/PA
额定电压 Rated voltage	1500VDC
额定脉冲电压 Rated impulse voltage	12KV
测试电压 Test voltage	8KV(50Hz,1min)
连接器接触电阻 Contact resistance	≤ 0.25 mΩ
金属导体材料 Contact material	铜, 镀锡 Copper, Tin plated
防护等级 Degree of protection	IP68
过压等级 Overvoltage category/Pollution degree	CATIII/2
安全等级 Safety degree	II
阻燃等级 Flame class	UL94-V0
插入力/拔出力 Insertion force/Withdrawal force	≤50N/≥50N
安装方式 Installation type	户外, 抗紫外线(F1) Outdoor, UV resistant(F1)
环境温度范围 Ambient temperature range	-40°C...+85°C(IEC)
符合标准 Regulatory approval	TUV/CE (IEC62852:2014)
适配电线规格 Suitable cable cross sections	1.5~10mm <sup>2</sup> /16~8AWG
温度上限 Upper limiting temperature	110°C(IEC)

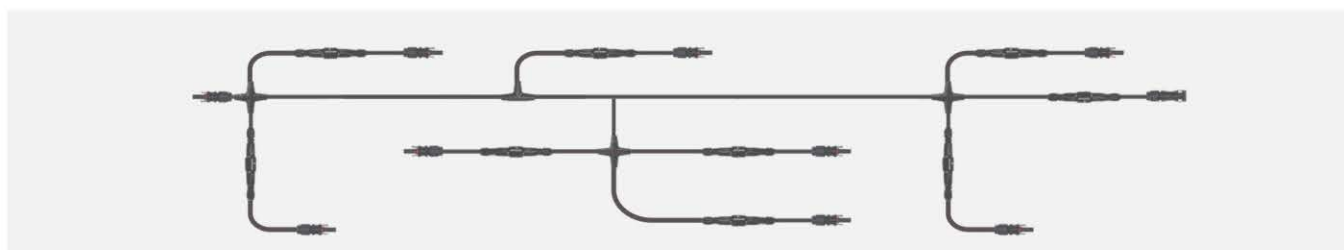
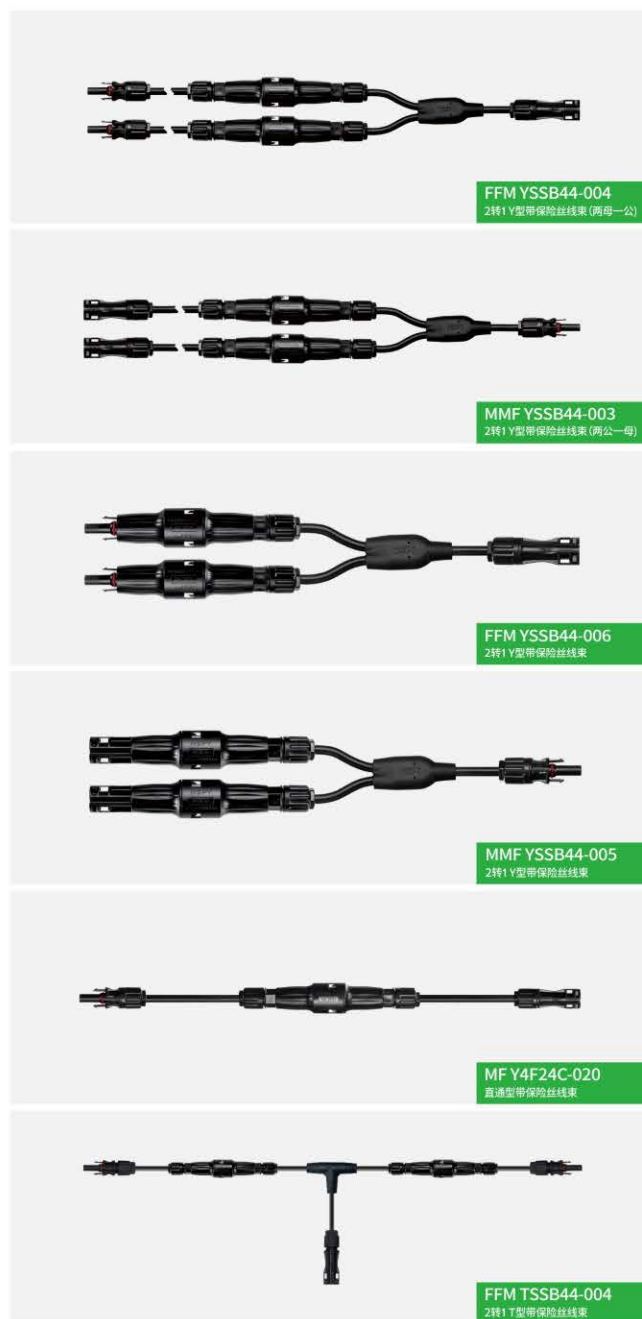

# 光伏线束 I

## PV CABLE ASSEMBLIES I

- Can be made according to your requirements  
可根据您的要求定制
- Weather resistant and UV resistant  
耐气候, 防紫外线 (抗UV)
- Certified by TUV, CE  
通过TUV/CE权威机构认证
- Multiple specifications to meet various needs  
各种规格齐全, 满足各种需求
- Use PV cable  
采用光伏专用线缆



### 产品规格 Product Specifications

绝缘材料 Insulation material	PPE/TPE/PA	阻燃等级 Flame class	UL94-V0
额定电压 Rated voltage	1000V/1500V	环境温度范围 Ambient temperature range	-40°C...+85°C(IEC)
额定脉冲电压 Rated Impulse voltage	16KV	温度上限 Upper limiting temperature	110°C(IEC)
测试电压 Test voltage	6KV/8KV (50Hz,1min)	插入力/拔出力 Insertion force/Withdrawal force	≤50N/≥50N
连接器接触电阻 Contact resistance	≤ 0.25 mΩ	安全等级 Safety degree	II
金属导体材料 Contact material	铜,镀锡 Copper,Tin plated	线材绝缘材质 Cable insulation material	XLPE
防护等级 Degree of protection	IP67/IP68	适配电线规格 Suitable cable cross sections	2.5~6mm <sup>2</sup> /14~10AWG
过压等级 Overvoltage category/Pollution degree	CATIII/2	电线导体材质 Cable conductor material	铜镀锡 Copper, tin plated

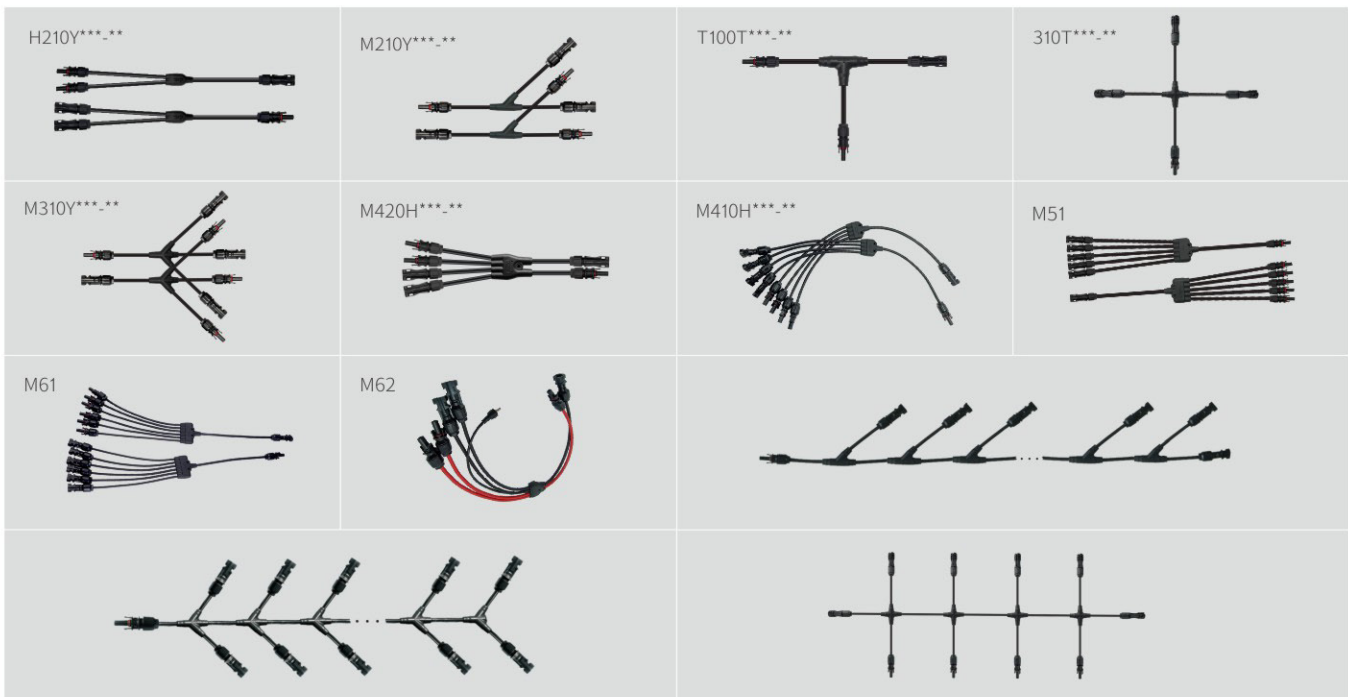

# 光伏线束 II

## PV CABLE ASSEMBLIES II

电缆规格 Cable Cross Sections	1.5mm <sup>2</sup> /2.5mm <sup>2</sup> /4.0mm <sup>2</sup> 6.0mm <sup>2</sup> (14AWG~10AWG)
光伏电缆长度 PV Cable Length	按客户规定/Customized
光伏连接器 PV Connectors	PV 3.0/ PV 4.0 Connectors
额定电压 Rated Voltage	1000V/1500V(TUV) 600V(UL)
额定电流 Rated Current	20A~30A
导体材料 Contact Material	铜、镀锡/Copper, Tin Plated
使用温度 Operating Temperature	-40°C ~ +85°C
电缆颜色 PV Cable Color	黑/红/黄/蓝 Black /Red /Yellow / Blue



### PV 4.0 电缆线束DC1000V/PV 4.0 Cable Assemblies DC1000V



### PV 3.0 电缆线束/PV 3.0 Cable Assemblies



### PV 4.0 电缆线束DC1500V/PV 4.0 Cable Assemblies DC1500V



# 电缆分支 | 免剥皮 快速安装

Cable branch  
Fast to install without cutting the main cable



**4进1出 4IN1**

## 电线电缆绝缘穿刺线夹

4 IN 1 INSULATION PIERCING CONNECTOR



免剥皮



安全



快速



抗UV





# 4进1出绝缘穿刺线夹

## 4 IN 1 INSULATION PIERCING CONNECTOR

- Quick branched without cutting main cable  
免剥皮快速分支
- Weather resistant and UV resistant  
耐气候, 防紫外线 (抗UV)
- Waterproof IP67 rating  
防水等级达到IP67
- Flame retardant material  
采用阻燃材质
- Patent product for utility models  
实用新型专利产品



### 产品规格 Product Specifications

产品型号 Product model	IPC4116120	安装方式 Installation type	户外, 抗紫外线(F1) Outdoor, UV resistant(F1)
绝缘材料 Insulation material	PA+CU	阻燃等级 Flame class	UL94-V0
额定电压 Rated voltage	1500VDC/1000VAC	安全等级 Safety degree	II
适配电线规格 Suitable cable cross sections	Tap:2.5~16mm <sup>2</sup> (OD Max.9.0) Main:10-120mm <sup>2</sup>	连接方式 Connection mode	锁接 Lock connection
连接器接触电阻 Contact resistance	≤ 5 mΩ	环境温度范围 Ambient temperature range	-40°C...+85°C(IEC)
金属导体材料 Contact material	铜, 镀锡 Copper, Tin plated	螺帽锁紧力 Nut cap locking force	>12Nm
防护等级 Degree of protection	IP67	适用范围 Application	电力电站 Power station
Overvoltage category/Pollution degree 过压等级	CATIII/2	温度上限 Upper limiting temperature	110°C(IEC)

### 产品尺寸 Product Size

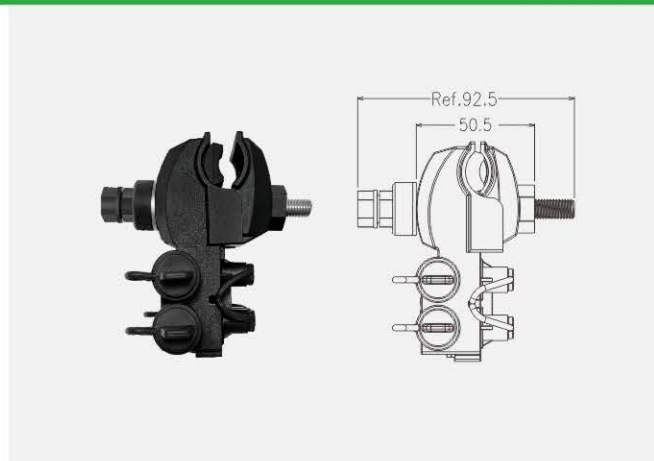
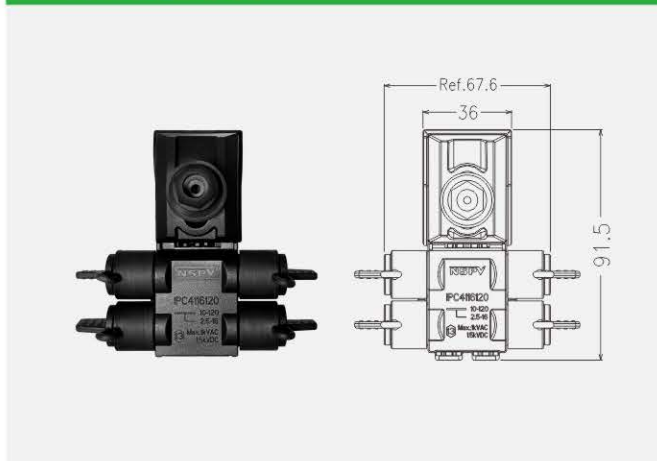

# 配件系列

## ACCESSORIES SERIES



**25mm波纹管-HD/MD 25MM CORRUGATED PIPE-HD/MD**

材料 Material	PVC	PVC
工作制类型 Duty type	高密度 Heavy duty	中密度 Medium duty
颜色 Colour	橙色 Orange	灰色 Grey
工作温度范围 Operating temperature range	-15°C until + 60°C	-15°C until + 60°C
内径尺寸 Inside Diameter	18.3mm	18.3mm
外径尺寸 Outside Diameter	25mm	25mm



**25mm UPVC电工管 UPVC ELECTRICAL CONDUIT 25MM MD**

材料 Material	UPVC	UPVC
硬度 Flexibility	硬管 Rigid	硬管 Rigid
工作制类型 Duty type	中密度 Medium duty	高密度 Heavy duty
颜色 Colour	灰色 Grey	橙色 Orange
壁厚 Wall Thickness	1.8mm	2.5mm
外径尺寸 Outside Diameter	25mm	25mm

### 25mm直管

25MM SOLID COUPLING



料号 Part No.	NS25MD-002
材料 Material	PVC
工作制类型 Duty type	中密度 Medium duty
颜色 Colour	灰色 Grey
耐冲击强度 Impact strength	高阻抗 High resistance
抗UV UV resistant	YES
壁厚 Wall thickness	2.5m
内径尺寸 Inside Diameter	25mm
长度 Length	48mm

### 25mm弯接管

25MM SOLID ELBOW



料号 Part No.	NS25HD-002
材料 Material	PVC
工作制类型 Duty type	高密度 Heavy duty
颜色 Colour	灰色 Grey
耐冲击强度 Impact strength	高阻抗 High resistance
抗UV UV resistant	YES
壁厚 Wall thickness	2.5m
内径尺寸 Inside Diameter	25mm
长度 Length	48mm

### 25mm三通接线盒

25MM JUNCTION BOX WITH 3WAYS ENTRIES



料号 Part No.	NS25MD-003
材料 Material	PVC
工作制类型 Duty type	中密度 Medium duty
颜色 Colour	灰色 Grey
耐冲击强度 Impact strength	高阻抗 High resistance
抗UV UV resistant	YES
开合长度 Tee Off length	69mm
内径尺寸 Inside Diameter	25mm
直线长度 In Line Length	108mm

## 单边扣 SINGLE PIPE CLAMP



材料 Material housing	铁 Ferrum
成品 Finish	镀锌 Zinc Plated
直径 Gauge	1.2mm
洞口尺寸 Hole diameter	5.2mm
长度 Length	56.5mm
宽度 Width	25mm
高度 Height	26mm

### 25mm Plain to Screwed Adaptor 25mm直管面板接头



料号 Part No.	HD2525-001	工作制类型 Duty type	重型 Heavy duty
材料 Material	PVC	连接类型 Connection type	平拧 Plain to screwed
模型 Model	直管 Straight	耐冲击强度 Impact strength	高阻抗 High resistance
结构类型 Construction type	外螺纹 External thread	抗UV UV resistant	Yes
螺纹类型 Thread type	公制 Metric	无卤化 Halogen free	No
颜色 Colour	灰色 Grey		

外螺纹 External thread	螺纹长度 Thread length	内直径 Inside Diameter	外直径 Outside Diameter	长度 Length
25mm	13.5mm	25mm	32mm	40mm

### Plain screwed adaptor 25mm 25mm软管接头



料号 Part No.	NSCG25-001
材料 Material	尼龙 Polyamide
结构类型 Connection type	外螺纹 External thread
颜色 Colour	灰色/黑色 Grey/Black
连接方式 Connection type	螺纹 Thread
工作温度范围 Operating temperature range	-15°C until +60°C
工作制类型 Duty type	高密度 Heavy duty
抗UV UV resistant	Yes
内含物 Inclusion	防松螺母 Locknut
螺纹连接尺寸 Thread connection size	M25x1.5
外螺纹 External thread	25mm

### Plain screwed adaptor 25mm M25 多孔接头

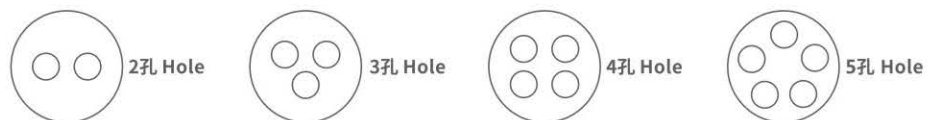

螺钉规格 Screw specification	公制牙 Metric
产品材质 Product material	部分以UL认可之尼龙PA66制成(防火等级UL94V-2),部分采用EPDM耐候橡胶制成 The part is made of UL-approved nylon PA66(Flame class UL94V-2), B and D is made of EPDM weather-resistant rubber
颜色种类 Colour Type	黑色及灰色 Black and grey
工作温度 Working temperature	-40°C-100°C
产品特性 Product feature	特殊夹紧爪与夹紧圈之设计, 夹紧电缆范围大, 抗拉力特强, 可防水, 防尘, 抗盐, 耐弱酸, 酒精, 油, 油脂及一般溶剂 Special clamping jaw and clamping ring design, large clamping cable range, strong tensile strength, waterproof, dustproof, salt resistant, weak acid, alcohol, oil, grease and general solvent



# 线缆夹

## SOLAR CABLE CLIP

- Holds solar cables perpendicular to the module frame mounting configurations.  
使太阳能电缆垂直于组件框架。
- Easy to install and detach without any tool.  
方便安装和拆卸, 无需任何工具。
- Coined edges to prevent cable insulation damages.  
压边, 防止损坏电缆外层。
- Could be used on modules with a flange thickness of 1.3 to 2.5mm.  
可用于法兰厚度为1.3至2.5毫米。
- Made of stainless steel for corrosion resistance.  
不锈钢精制而成, 耐腐蚀。



### 产品规格 Product Specifications



## 太阳能接地线夹 SOLAR EARTHING CLAMP

- User-friendly design and easy installation  
人性化设计安装简易
- Suitable for C-type\ U steel and H-type channel steel  
适合各种光伏发电板C型\U型钢及H型钢槽钢等
- Tinned copper material, durable  
铜镀锡材质, 经久耐用
- Stainless steel screw, anti-rust anti-corrosion  
不锈钢螺丝防锈防腐
- Support customization, short delivery time  
支持定制 货期短



### 产品参数/Product parameter

产品型号 Product Model	L08001-***
产品材质 Product Material	铜/304不锈钢 Copper/SUS304
产品颜色 Product Color	白色White
支架的厚度范围 Frame Thickness Range	0.8-4.5mm
环境温度范围 Ambient temperature range	-40°C...+85°C(IEC)
使用寿命 Warranty	25年 25 Year

### 产品尺寸/Product size

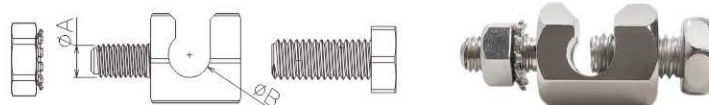

料号/Part number	A	B	适配电线/Cable size
L08001-001	5	6.8	6.8
L08001-002	4	5.5	5.5
L08001-003	6	10	10

## 防水盖片 ROOF FLASHING

- Quality assurance for 25 years  
25年品质保证
- Round and square waterproof cover suitable for any shape of roof  
圆形和方形防水盖片适合任何形状的屋面
- Resist to extreme temperatures - 50 degrees to 200 degrees  
可承受极端气温-50度至200度
- No crease, no leakage  
不产生折皱, 无渗漏隐患
- Imported rubber raw material  
进口橡胶原料



### 产品参数/Product parameter

产品型号 Product Model	L07001-***
产品材质 Product Material	硅橡胶 Silicon rubber
产品颜色 Product Color	黑色/红色/灰色 Black / Red / Gray
产品外缘 Product Rim	铝合金 Aluminium alloy
产品厚度 Product Thickness	1.5-2.0mm
使用寿命 Warranty	25年 25 Year

Rainbow quick stitching silicone waterproof cover is designed for roof waterproof, especially suitable for all kinds of round tubular impervious requirements, but before installation it must be cut to the appropriate size according to the outside diameter of the pipe.

快速缝合硅胶防水盖片是专为屋面防水设计的, 特别适于各种圆管状的防渗要求, 但在安装前必须根据管子的外径裁切至合适的尺寸。



## 光伏4线接线盒 PV 4 RAILS JUNCTION BOX

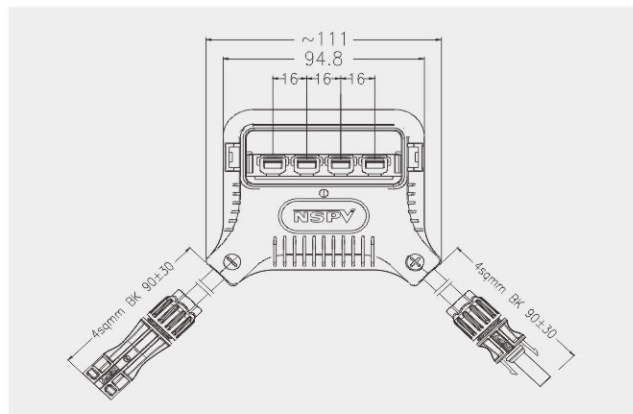

### 产品规格 Product Specifications

绝缘材料 Insulation material	PPE/PA	安全等级 Safety degree	II
额定电压 Rated voltage	1500V (IEC)	阻燃等级 Flame class	UL94-V0
额定电流 Rated current	14A(Diode 25A)	二极管数量 Diode Number	Each 3PC
测试电压 Test voltage	8KV(50Hz,1min)	环境温度范围 Ambient temperature range	-40°C...+85°C(IEC)
连接器接触电阻 Contact resistance	≤ 0.25 mΩ	适配电线规格 Suitable cable cross sections	2.5-6mm <sup>2</sup> (14-10AWG)
金属导体材料 Contact material	铜,镀锡 Copper,Tin plated	电缆外径(mm) Range of cable gland(mm)	O.D.:4.8-6.2
防护等级 Degree of protection	IP67(In potting)	温度上限 Upper limiting temperature	110°C(IEC)
汇流条连接 Connection of bus ribbons	Clamp	汇流条尺寸 Ribbons size(mm)	6(W)*0.2-0.4(T)

## 光伏小型接线盒 PV MINI JUNCTION BOX

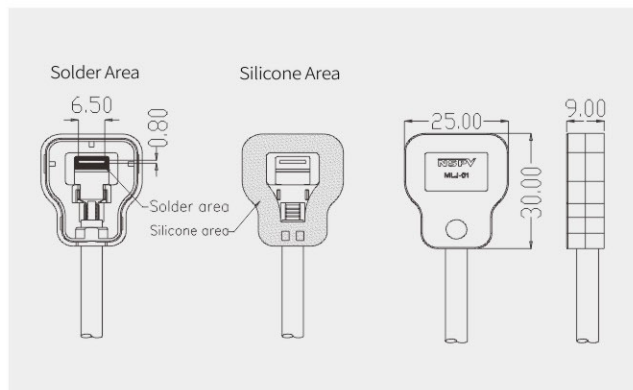

### 产品规格 Product Specifications

绝缘材料 Insulation material	PPE/PA	安全等级 Safety degree	II
额定电压 Rated voltage	1000V (IEC)	阻燃等级 Flame class	UL94-V0
额定电流 Rated current	20A	二极管数量 Diode Number	Non
测试电压 Test voltage	6kV(50Hz,1min)	环境温度范围 Ambient temperature range	-40°C...+85°C(IEC)
连接器接触电阻 Contact resistance	≤ 0.25 mΩ	适配电线规格 Suitable cable cross sections	2.5/4.0mm <sup>2</sup>
金属导体材料 Contact material	铜,镀锡 Copper,Tin plated	电缆外径(mm) Range of cable gland(mm)	O.D.:5.5
防护等级 Degree of protection	IP67(In potting)	温度上限 Upper limiting temperature	110°C(IEC)
汇流条连接 Connection of bus ribbons	焊接Solder	汇流条尺寸 Ribbons size(mm)	6.5(W)*0.2-0.8(T)

# PV-NEHP01接线盒

PV-NEHP01 JUNCTION BOX

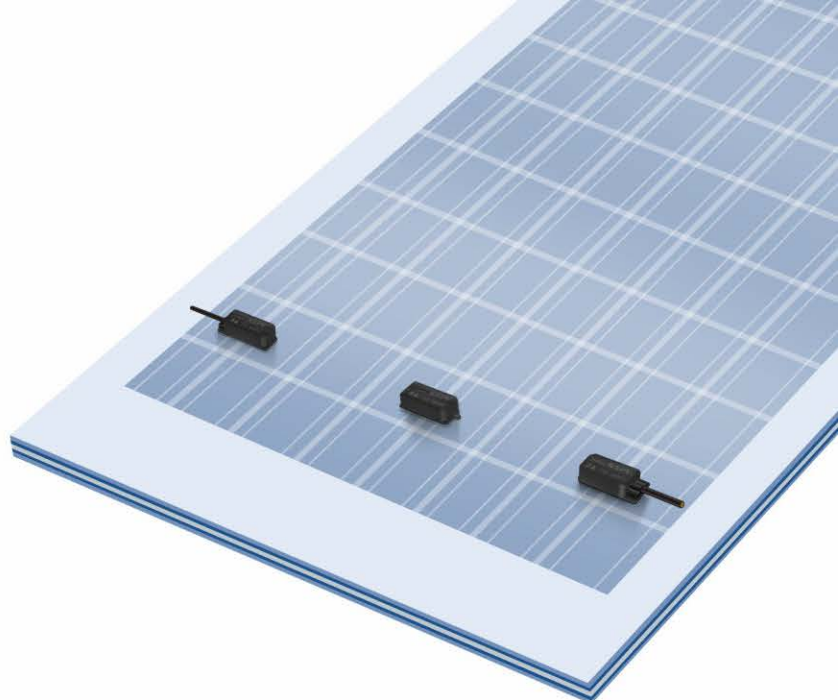

- Flame retardant material  
采用绝缘阻燃材质
- Small and beautiful appearance  
体积小巧 美观
- Multiple matches to meet various needs  
多种搭配组合满足需求
- Waterproof grade up to IP68  
防水等级达到IP68
- Glue filling design  
灌胶密封设计

## 产品规格 Product Specifications

接线盒本体材料 BOX Material	PPE/PA	安全等级 Safety degree	II
额定电压 Rated voltage	1500VDC	阻燃等级 Flame class	UL94-V0
额定电流 Rated current	30A(With diode)	二极管数量 Diode Number	Each 1PC
测试电压 Test voltage	8kV(50Hz,1min)	环境温度范围 Ambient temperature range	-40°C...+85°C(IEC)
连接器接触电阻 Contact resistance	≤ 0.25 mΩ	适配电线规格 Suitable cable cross sections	6mm <sup>2</sup> (10AWG)
金属导体材料 Contact material	铜, 镀锡 Copper, Tin plated	电缆外径(mm) Range of cable gland(mm)	O.D.:6.0
防护等级 Degree of protection	IP68(In potting)	温度上限 Upper limiting temperature	110°C(IEC)
汇流条连接 Connection of bus ribbons	焊接 Solder	汇流条尺寸 Ribbons size(mm)	Max.8(W)*0.2-0.5(T)

## 产品尺寸 Product Size

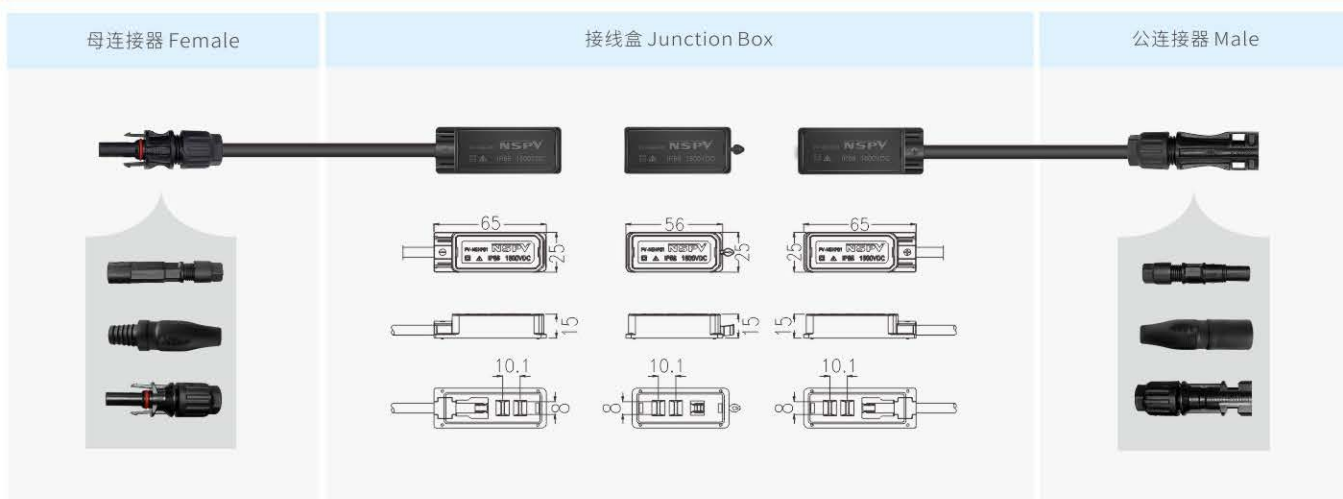

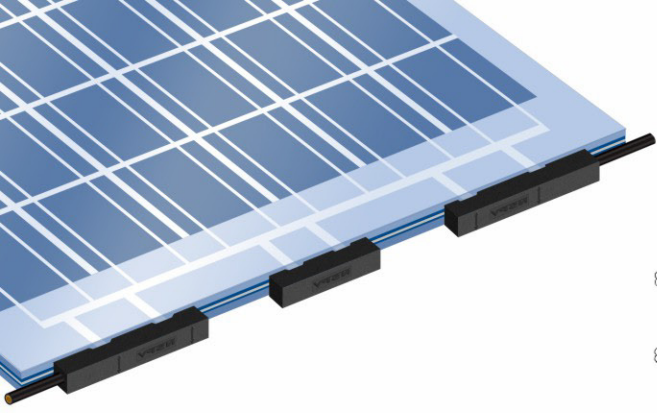

## 薄膜专用接线盒 BIPV JUNCTION BOX

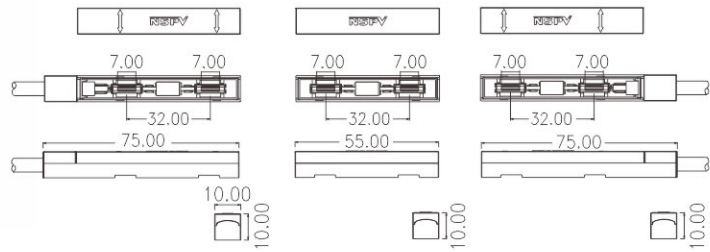

### 产品规格 Product Specifications

接线盒本体材料 BOX Material	PPE/PA	阻燃等级 Flame class	UL94-V0
额定电流 Rated current	10A(Diode 15A)	过压等级 Overvoltage category/Pollution degree	CATIII/2
额定电压 Rated voltage	1000V DC	环境温度范围 Ambient temperature range	-40°C...+85°C(IEC)
测试电压 Test voltage	6kV(50Hz,1min)	适配电线规格 Suitable cable cross sections	2.5~4mm <sup>2</sup>
接触电阻 Contact resistance	≤ 0.25 mΩ	二极管数量 Diode Number	Each 1PC
导体材料 Contact material	铜,镀锡 Copper,Tin plated	温度上限 Upper limiting temperature	110°C(IEC)
防护等级 Degree of protection	IP67(In potting)	电缆外径 Range of cable gland(mm)	O.D.:5.5
安全等级 Safety degree	II	汇流条尺寸 Ribbons size(mm)	6(W)*0.2-0.4(T)

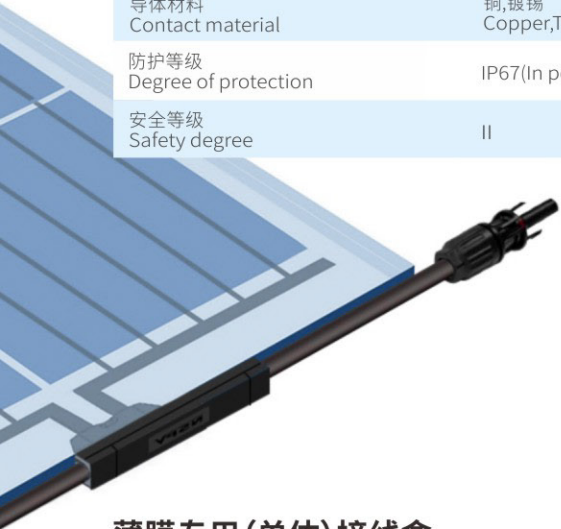

## 薄膜专用(单体)接线盒 BIPV SINGLE JUNCTION BOX

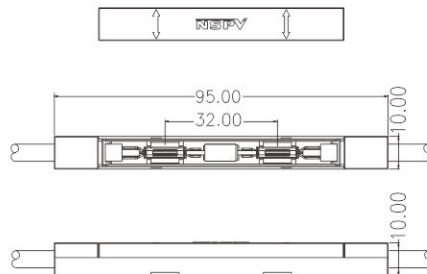

### 产品规格 Product Specifications

绝缘材料 Insulation material	PPE/PA	安全等级 Safety degree	II
额定电压 Rated voltage	1000V (IEC)	阻燃等级 Flame class	UL94-V0
额定电流 Rated current	10A(Diode 15A)	二极管数量 Diode Number	Each 1PC
测试电压 Test voltage	6kV(50Hz,1min)	环境温度范围 Ambient temperature range	-40°C...+85°C(IEC)
连接器接触电阻 Contact resistance	≤ 0.25 mΩ	适配电线规格 Suitable cable cross sections	2.5/4.0mm <sup>2</sup>
金属导体材料 Contact material	铜,镀锡 Copper,Tin plated	电缆外径(mm) Range of cable gland(mm)	O.D.:5.5
防护等级 Degree of protection	IP67(In potting)	温度上限 Upper limiting temperature	110°C(IEC)
汇流条连接 Connection of bus ribbons	压接 Clamp	汇流条尺寸 Ribbons size(mm)	6(W)*0.2-0.4(T)





## EC1+EC2边接线盒

EC1+EC2 EDGE CONNECTOR

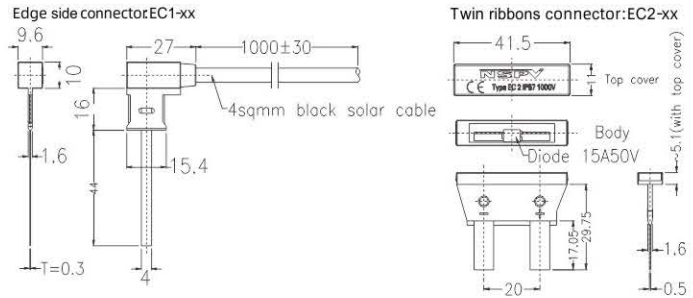

### 产品规格 Product Specifications

绝缘材料 Insulation material	PA/CU	保护等级 Degree of protection	IP68(In potting)
额定电压 Rated voltage	1000V&1500VDC	适配电线规格 Suitable cable cross sections	2.5~4mm <sup>2</sup> /14~12AWG
额定脉冲电压 Rated impulse voltage	16KV	安全等级 Safety degree	II
测试电压 Test voltage	6kV/8kV(50Hz,1min)	阻燃等级 Flame class	UL94-V0
连接器接触电阻 Contact resistance	≤ 0.25 mΩ	安装方式 Installation type	户外, 抗紫外线(F1) Outdoor,UV resistant(F1)
金属导体材料 Contact material	铜,镀锡 Copper,Tin plated	环境温度范围 Ambient temperature range	-40°C...+85°C(IEC)
防护等级 Degree of protection	IP68(In potting)	温度上限 Upper limiting temperature	110°C(IEC)
连接方式 Connection mode	焊接 Soldering	产品颜色 Product color	黑色 Black



## EC03边接线盒

EC03 EDGE CONNECTOR

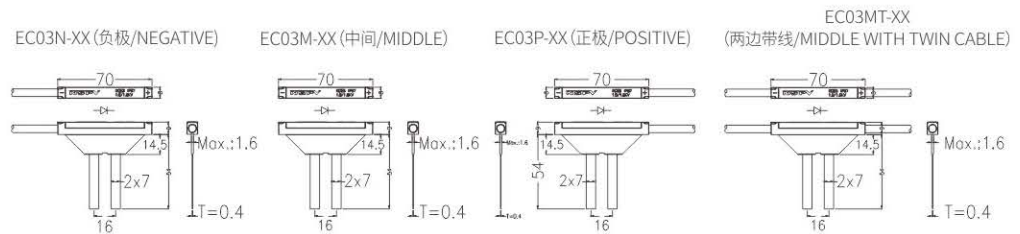

### 产品规格 Product Specifications

接线盒本体材料 BOX Material	PA/CU	安全等级 Safety degree	II
额定电压 Rated voltage	1000V&1500VDC	阻燃等级 Flame class	UL94-V0
额定电流 Rated current	Max.15A(Diode 20A)	二极管数量 Diode Number	Each 1PC
测试电压 Test voltage	8kV(50Hz,1min)	环境温度范围 Ambient temperature range	-40°C...+85°C(IEC)
连接器接触电阻 Contact resistance	≤ 0.25 mΩ	适配电线规格 Suitable cable cross sections	2.5~4mm <sup>2</sup> /14~12AWG
金属导体材料 Contact material	铜,镀锡 Copper,Tin plated	电缆外径(mm) Range of cable gland(mm)	O.D.:5.5
防护等级 Degree of protection	IP67(In potting)	温度上限 Upper limiting temperature	110°C(IEC)
汇流条连接 Connection of bus ribbons	焊接 Soldering	汇流条尺寸 Ribbons size(mm)	2x7.0

# ITERATIVE DC PV COMBINER BOX

## 迭代直流光伏汇流箱



散热快



易安装



空间大

◆ 产品设计、制造严格依据IEC61439-1,IEC61439-2, IEC62109-1等标准, 外箱采用高强度玻璃纤维箱, 防护等级可达IP67, 绝缘性能良好, 安全可靠。

Product design and manufacturing strictly comply with IEC61439-1,IEC61439-2,IEC62109-1 and other standards. The housing adopts high-strength glass fiber box, and the protection level can reach IP67 with good insulation performance, safe and reliable.



耐腐蚀



寿命长



低成本

◆ 采用外置式光伏熔断器, 额定电流可达50A (实际情况配置不同) 可在多样的气候环境下使用, 温度适用范围广。

Use external solar fuse connector with rated current up to 50A (the actual configuration is different). It can be used in a variety of climatic environments and has a wide range of temperature applications.

◆ 安装方式: 挂接安装, 提供可靠安装挂角。

Installation method: Hook installation with reliable installation angle.

\*可根据你的要求定制  
Can be made according to your requirements

# 汇流箱

## COMBINER BOX



不锈钢材质 Stainless steel

钢板喷塑材质  
Metal plastic sprayed

塑壳材质 Plastic

### 产品规格 Product Specifications

技术数据 Technical data	2-32路输入 2-32 Strings Combiner Boxes
材料 Material	PPO/PC/Matel+Plastic sprayed surface
防护等级(根据EN 60529) Degree of protection (according to EN 60529)	IP67/IP65
外观颜色 Exterior Color	黑色/Black 米白色/Off white
最大直流电压 Max. open circuit DC voltage	1000V DC
最大输入直流短路电流 Max. DC short circuit current per input	20A DC/15A DC
浪涌保护装置 Surge protection Device	1000V DC 40KA
直流输入的数量(正负=一个输入) Number of DC inputs (plus and minus = one input)	2-32
连接直流输入电缆(+) Connection DC input cables (+) to	Fuse holder(0.75mm <sup>2</sup> -25mm <sup>2</sup> )
连接直流输入电缆(-) Connection DC input cables (-) to	Fuse holder(0.75mm <sup>2</sup> -25mm <sup>2</sup> )
保险丝 Fuses	需要/With Fuse
直流输出的数量(正负=一个输出) Number of DC outputs (plus and minus = one output)	1
连接电缆直流输出 Suitable cable cross section(DC output)	4-150mmsq
最大输出断路器电流(A) Max. output circuit breaker current(A)	63A-800A



## NSPV光伏并网箱

### NSPV PV GRID DISTRIBUTION BOX

环境条件 Ambient condition	
工作温度 Working temperature	-25°C~50°C
储存温度 Storage temperature	-40°C~70°C
海拔高度 Above sea level	≤2000m (海拔2000m以上需降容) Need to derate if more than 2000m above sea level
耐盐雾 Salt fog tolerance	实验168h (可定制) Experiment 168h (customizable)
电气参数 Electrical parameters	
绝缘电压 Dielectric withstand voltage	AC 800V
适用装机容量 Applicable installed capacity	3~60kW
适用电路 Applicable circuit	单相/3相 Single-phase / 3-phase
输入输出电流路数 Input / Output current path	输入1~2路, 输出1路 Input 1~2 route, output 1 route
额定工作电压 Rated working voltage	AC 230V/400V
额定电流 Rated current	6~100A
断路器分断能力Lcu MCB capacity Lcu	6kA/10kA
输入逆变器功率 Inverter input power	3kW~60kW
安全保护 Safety protection	
浪涌保护 SPD protection	有 With
短路保护 Short-circuit protection	有 With
过载保护 Overload protection	有 With
漏电保护 Earth leakage protection	有/可选 With/can choose
孤岛保护 Island protection	有 With
检有压重合闸 Check pressure reclosing	有 With

## DC1000V光伏保险丝座

1000VDC DIN RAIL FUSE HOLDER

### 产品规格 Product Specifications

产品型号 Part No.	NSFU30-001	产品极数 Poles	1/2/3
绝缘材料 Insulation material	PA	保险丝数量 Number of fuses	1/2/3
额定电压 Rated Voltage	1000VDC	保险丝尺寸 Fuse size	PV-30/10x38
额定电流 Rated current	MAX:32A	导线范围 Wire range	1-10mm <sup>2</sup>

### 产品尺寸 Product Size

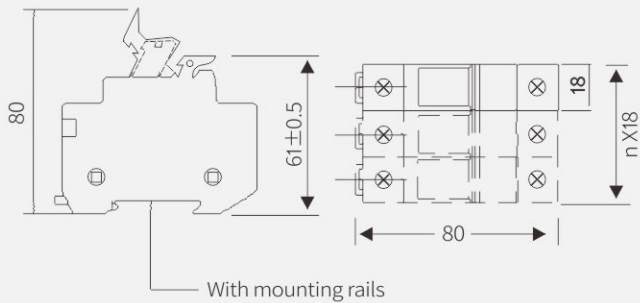

## 光伏发电保护用熔断器DC1000V

SOLAR FUSE DC1000V

### 产品规格 Product Specifications

产品型号 Product model	NSPV-25	额定电压(V) Rated Voltage	1000VDC
外形尺寸 Overall dimension	10X38	额定电流(A) Rated current	1-30

### 产品尺寸 Product Size

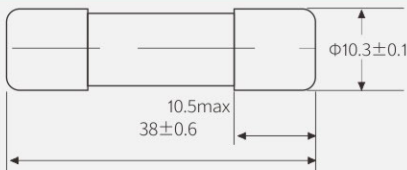

## DC1500V光伏保险丝座 1500VDC DIN RAIL FUSE HOLDER

### 产品规格 Product Specifications

绝缘材料 Insulation material	PA	阻燃等级 Flame class	UL94-V0
额定电流 Rated current	MAX:50A	金属导体材料 Contact material	铜,镀锡 Copper,Tin plated
额定电压 Rated voltage	1500VDC	接触电阻 Contact resistance	≤0.25mΩ
测试电压 Test voltage	AC3kV	导轨规格 Rail spec.	TH35

### 产品尺寸 Product Size

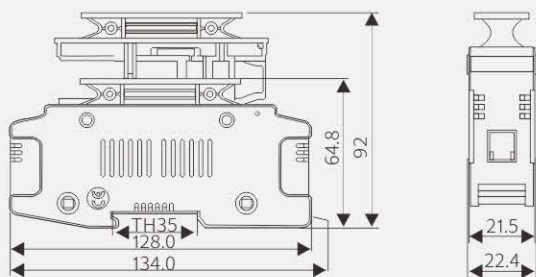

## 光伏发电保护用熔断器DC1500V SOLAR FUSE DC1500V

### 产品规格 Product Specifications

额定电压 Rated Voltage	1500VDC	使用类别 Classes	gPV
分断能力 Breaking capacity	20/30KA	储存湿度 Storage humidity	≤90%
额定脉冲电压 Rated Impulse voltage	1575V	工作温度 Working temperature	-40C°~+85C°
额定电流 Rated current	2A,3A,3.5A,4A,5A,6A,8A,10A,12A,15A,16A,20A,25A,30A,32A,40A,50A		
安装地点 Installation site	海拔不超过2000米 The altitude does not exceed 2000m		
参考标准 Reference standard	IEC60269-1/GB13539-1/IEC60269-6/GB13539-6		
安装方式 Installation method	保险丝座或保险丝连接器 Fuse holder or fuse connector		
保险丝尺寸 Fuse size	10×85/14×85/10×109/14×109		



### 产品尺寸 Product Size

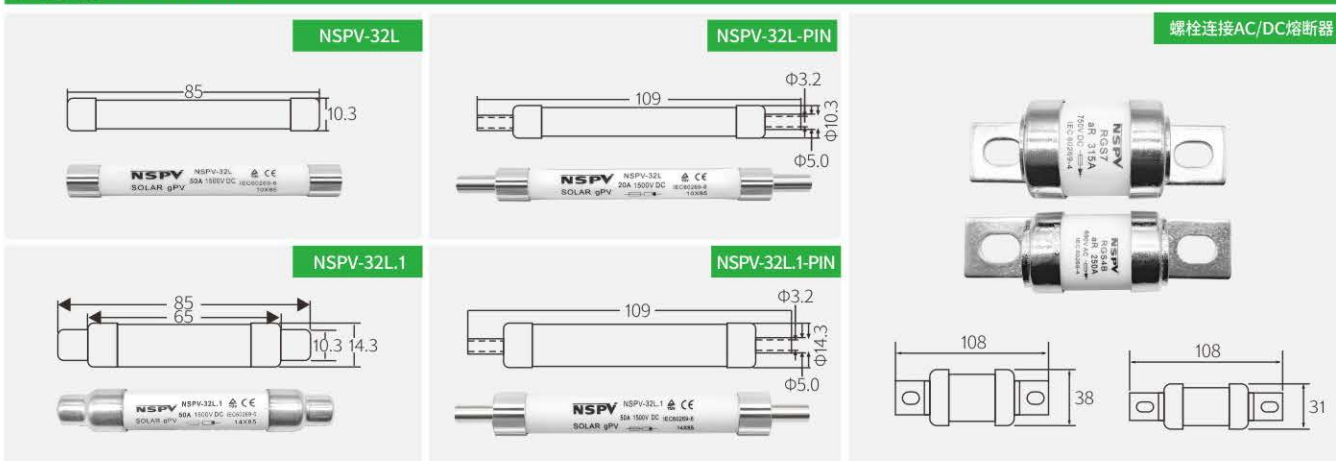

## 交流小型断路器 AC MINIATURE CIRCUIT BREAKER

### 产品规格 Product Specifications

产品型号 Part No.	N47Z	产品极数 Poles	1P/2P/3P/4P
安装轨道 Installation track	35X7.5	特性曲线 Characteristic	B,C,D
额定电压(V) Rated Voltage(V)	125/250/375/500	极限分段能力Icu Ultimate breaking capacity Icu(kA)	6
额定电流 Rated current	16A,20A,25A,32A,40A,50A,63A,80A,100A,125A		



## 直流小型断路器 DC MINIATURE CIRCUIT BREAKER

### 产品规格 Product Specifications

产品型号 Part No.	NL7-63	产品极数 Poles	1P/2P/3P/4P
曲线类型 Curve type	B/C	极限分段能力Icu Ultimate breaking capacity Icu(kA)	6
额定电压(V) Rated Voltage(V)	250V/500V/750V/800V/1000V/1200V		
额定电流 Rated current	1A,2A,3A,4A,5A,6A,10,16A,20A,25A,32A,40,50,63A		



## 小型断路器防水盒 MCB ENCLOSURE BOX

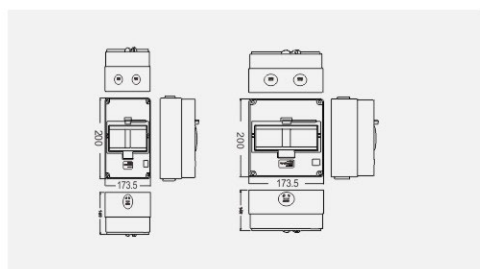

产品参数 Product parameters	4P防水盒 SPB 4 WAYS	8P防水盒 SPB 8 WAYS
最多可并联数量/Max no of strings	4	8
防护等级/Waterproof Class	IP66	
产品材质/Material	ABS / PC	
是否配有防浪涌 Could match with surge arrester	YES	
是否有断路器 Could match with circuit breaker	YES	
是否配有保险丝座 Could match with fuse holder	YES	

## 小型断路器锁 MCB LOCKOUT



### 产品规格 Product Specifications

产品名称 Product Name	小型断路器锁 MCB Lock dogs; MCB Toggle Lock
材质 Material	铝合金、高张力 Aluminum alloy, high tension
包装 Package	100PCS/bag
包装重量 Package Weight	0.48kg (0.99lb.)

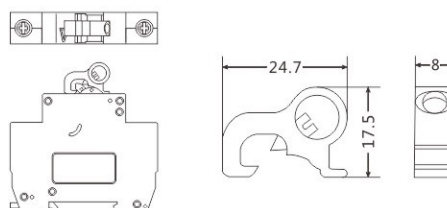

## 直流塑壳断路器 DC MCCB



DC MCCB	NM1-125 PV	NM1-400 PV	NM1-800 PV
额定持续电流 Rated continuous current $I_{nm}$	125	400	800
额定电流 Rated current/ $I_n$ (A)	16/20/25/32/40/50/63/80/100/125	250/315/350/400	630/700/800
额定工作电压 Rated voltage $U_e$ (V) DC	250V/500V/750V/1000V	500V/750V/1000V/1500V	500V/750V/1000V/1500V
额定绝缘电压 Rated Insulation Voltage $U_i$ (V)	1000V	1000V	1000V/1200V
额定冲击耐受电压 Rated impulse withstand voltage $U_{imp}$ (kV)	8KV	8KV	8KV
是否具有隔离特性 Whether with isolation features		YES	
标准 Standard	IEC 60947-2/IEC60947-1/GB 14048.1/GB 14048.2		
标准允许环境温度 Permitted ambient temperature ( $^{\circ}$ C)	-25 $^{\circ}$ C ~ +50 $^{\circ}$ C		
防护等级 Degree of protection	IP20		
可带附件 Optional accessories 辅助/报警/分励/手操/电操/机械联锁-Auxiliary switch、Alarm switch、Shunt release、Rotary handle、Motor-driven handle、Mechanical interlock			
飞弧距离 Flashover distance (mm)	$\geq 50$		
瞬时动作值 Instantaneous operation	20 $I_n$		
安装方式 Installation	固定式、插入式/Stationary, plug-in type		

## 光伏防雷电涌保护器 PV SURGE PROTECTIVE DEVICE (SPD)

### 产品规格 Product Specifications

额定电压 Rated voltage	$U_n$	1000V DC
最大持续工作电压 Max.continuous d.c. voltage[(L+/L-)->PE]/[L+->L-]	$U_{cpv}$	1060V DC
最大放电电流 (8/20 $\mu$ s) Maximum discharge current (8/20 $\mu$ s)	$I_{max}$	40KA
标称放电电流 (8/20 $\mu$ s) Nominal discharge current (8/20 $\mu$ s)	$I_n$	20KA
电压保护水平 Voltage protective level at $I_n$	$U_p$	$\leq 3.6KV$
防护等级 Degree of protection		IP20
外壳材料 Housing material		UL94V0
适配电线规格 Cable cross sections		10-35平方, cable size 10-35sqmm By screw terminal:10-35mm <sup>2</sup> By connection bus



## TB接线座2-20P

### TB TERMINAL BLOCK 2-20P



### 产品参数 Product parameter

型号 Model	TB-01
绝缘材料 Insulation material	PBT
额定电流/电压(直流) Rated current/Voltage(DC)	Max.:50A/1000VDC
额定电流/电压(交流) Rated current/Voltage(AC)	Max.:60A/690VAC
测试电压 Test voltage	4kV(50Hz,1min)
金属导体材料 Contact material	铜,镀锡 Copper,Tin plated

# NSI01-32P光伏隔离开关





## NSI01-32P SOLAR ISOLATOR SWITCH

本产品应用于光伏系统中,使用电压可达到1500VDC。  
本产品机构动作速度快,能快速分断触头;本产品类别为DC21B。

The product is used in solar system, the voltage can reach 1500VDC; The mechanism of the product move fast, breaking the contact quickly; And the category is DC21B.

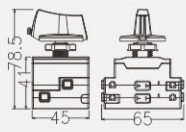
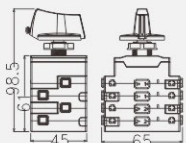
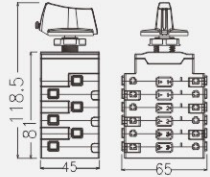
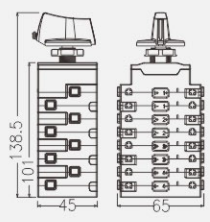

### 产品规格 Product specifications

NSI01-32P2	NSI01-32P4	NSI01-32P6	NSI01-32P8
			
			

### 产品信息 Product Information

产品型号 Model No.	NSI01-32P-**		NSI01-32P-**	NSI01-32P-**	NSI01-32P-**	NSI01-32P-**	
额定电压 Rated voltage	Ue	V	1000	1000	1000	1000	1500
额定电流 Rated current	le	A	16	20	25	32	16
额定发热电流 Rated Heating current	lth	A	32				16
额定绝缘电压 Rated insulation voltage	Ui	V	1500				
安装方式 Installation method	Panel Type						
电寿命 Electric life		time	1000				
机械寿命 Mechanical life		time	20000				
IP等级 IP level	IP20						
环境温度 Ambient temperature		°C	-40°C~+70°C				



# AC开关

## AC SWITCH

此款隔离开关防水等级IP66, 具有耐候、坚固的特点, 几乎适用于任何外部环境。双夹紧螺钉以固定接地和中性连接杆, 每个通道提供了相等的电缆剥离长度, 确保夹紧所有电缆。

The IP66 Weatherproof Isolator Switch is a robust range of switches suitable for virtually any external application. Fixed earth and neutral connector bars with dual clamping screws per tunnel provide equal stripping lengths and secure clamping for all cables.



料号/Part No.	极点/Poles	额定电流/Rated current	额定电压/Rated voltage	终端/Terminals (mm <sup>2</sup> )
NSAC1P-***	1	20/30/63A	250V	2.5~16
NSAC2P-***	2	20/35/63A	440V	2.5~16
NSAC2P-***	2	25A	400/500/690V	4
NSAC2P-***	2	40A	400/500/690V	6~10
NSAC3P-***	3	20/35/55/63A	440V	2.5~16
NSAC3P-***	3	63A	400/500/690V	4~16
NSAC4P-***	4	55/63/80A	440V	16

# DC开关

## DC SWITCH

此款隔离开关防水等级IP66, 具有耐候、坚固的特点, 几乎适用于任何外部环境。双夹紧螺钉以固定接地和中性连接杆, 每个通道提供了相等的电缆剥离长度, 确保夹紧所有电缆。

The IP66 Weatherproof Isolator Switch is a robust range of switches suitable for virtually any external application. Fixed earth and neutral connector bars with dual clamping screws per tunnel provide equal stripping lengths and secure clamping for all cables.



DC21B评级 DC21B Rating					
600V	700V	800V	900V	1000V	Poles in series
12A	12A	10A	9A	6A	2
16A	16A	16A	13A	9A	2
20A	20A	18A	14A	10A	2
25A	23A	20A	16A	11A	2
32A	27A	23A	20A	13A	2
29A	16A	16A	13A	9A	2
45A	23A	20A	16A	11A	2
50A	27A	23A	20A	13A	2
16A	16A	16A	16A	16A	4
25A	25A	25A	25A	25A	4
32A	32A	32A	32A	32A	4

# 光伏安装工具

## PV INSTALLATION TOOLS

- Suitable for cable cross sections 2.5mm<sup>2</sup>, 4mm<sup>2</sup>, 6mm<sup>2</sup>.  
适用于截面积为2.5mm<sup>2</sup>, 4mm<sup>2</sup>和6mm<sup>2</sup>的线缆。
- Solar cable crimper can crimp lathing pins or stamping pins.  
压线钳可铆车件或者冲压件端子。
- Used for crimping a small amount of PV cables.  
适用于少量的光伏线缆的铆接。



### 产品参数 Product parameters

型号 Model	口模类型 Type	线缆尺寸 Cable Size (mm <sup>2</sup> )	铆接端子规格 Contact pins specification
L02001-***	Mold A	2.5/4.0/6.0	2.5/4.0/6.0mm <sup>2</sup> 冲压端子(stamping pins) 4mm <sup>2</sup> 车件端子(lathing pins)
	Mold B	2.5/4.0/6.0	2.5/4.0/6.0mm <sup>2</sup> 车件端子 (lathing pins)
L02002-001		10.0/16.0	10/16mm <sup>2</sup> 车件端子 (lathing pins)

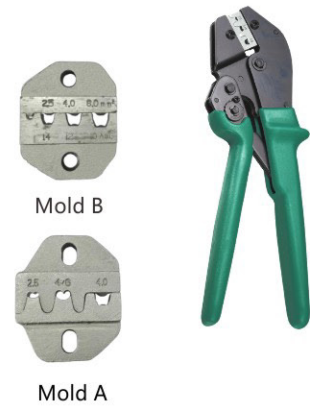

# 光伏警示牌

## PV SOLAR LABEL

### 产品规格 Product Specifications

背胶材料/ Adhesive material	ABS+3M
颜色/Color	红色/白色/黑色/黄色/绿色 (Red/White/Black/Yellow/Green)
使用范围/Application	在太阳能光伏系统警告或指示标签/Warning or indication label in solar PV system

Solar d.c. in conduits have been installed in this ceiling space  
The conduit is labelled “SOLAR”  
and care must be taken while working nearby. The internal solar d.c. cables may be live and must not be disturbed or damaged



**WARNING**  
MULTIPLE D.C. SOURCES  
TURN OFF ALL D.C. ISOLATORS TO ISOLATE EQUIPMENT



**WARNING**  
MULTIPLE SUPPLIES  
ISOLATE ALL SUPPLIES BEFORE WORKING ON THIS SWITCHBOARD

SOLAR ARRAY ON ROOF

OPEN CIRCUIT VOLTAGE    V  
SHORT CIRCUIT CURRENT    A



**WARNING**  
HAZARDOUS D.C. VOLTAGE

PV  
DP

PV ARRAY D.C.ISOLATOR

INVERTER A.C. ISOLATOR

PV ARRAY D.C.ISOLATOR

MAIN SWITCH GRID SUPPLY

MAIN SWITCH GRID SUPPLY

Inverter Location

**SHUTDOWN PROCEDURE**

1. Turn off the “Main Switch Inverter Supply” or A.C. Isolator  
2. Turn off the “ PV Array D.C Isolator” located at the inverter.  
WARNING: Do not open plug and socket connections or PV array DC Isolator under load.  
WARNING: PV array D.C. Isolators do not de-energise the PV array and array cabling.  
Start-up Procedure is the reverse of the Shutdown Procedure



**WARNING PV STRING DISCONNECTION POINT**



**WARNING PV STRING DISCONNECTION POINT**



**WARNING**  
PV ARRAY DC ISOLATORS DO NOT DE-ENERGIZE THE PV ARRAY AND ARRAY CABLING



**WARNING HAZARDOUS D.C. VOLTAGE**



WARNING: LOADS MUST BE ISOLATED AND CIRCUIT MUST BE TESTED FOR THE ABSENCE OF CURRENT BEFORE UNPLUGGING



WARNING: LOADS MUST BE ISOLATED AND CIRCUIT MUST BE TESTED FOR THE ABSENCE OF CURRENT BEFORE UNPLUGGING



WARNING: LOADS MUST BE ISOLATED AND CIRCUIT MUST BE TESTED FOR THE ABSENCE OF CURRENT BEFORE UNPLUGGING



WARNING: LOADS MUST BE ISOLATED AND CIRCUIT MUST BE TESTED FOR THE ABSENCE OF CURRENT BEFORE UNPLUGGING

\*可根据你的要求定制  
Can be made according to your requirements

东莞市新金阳光电科技有限公司  
NewSun PV Technology Co.,Ltd.

东莞市长安镇新安社区横岗头工业园168制造大厦12A

12A, 168 Building, Henggangtou Industrial Zone, Xin'an Community, Chang' an Town, Dongguan City, Guangdong 523883. China

▪ TEL : 86-769-85371660 ▪ FAX: 86- 769-81871001 ▪ E-mail: info@new-pv.com ▪ Website: www.new-pv.com

© Copyright 2023, NewSun PV Technology Co.,Ltd. Printed in May 2023. 本手册所载信息如有变更,恕不另行通知。