

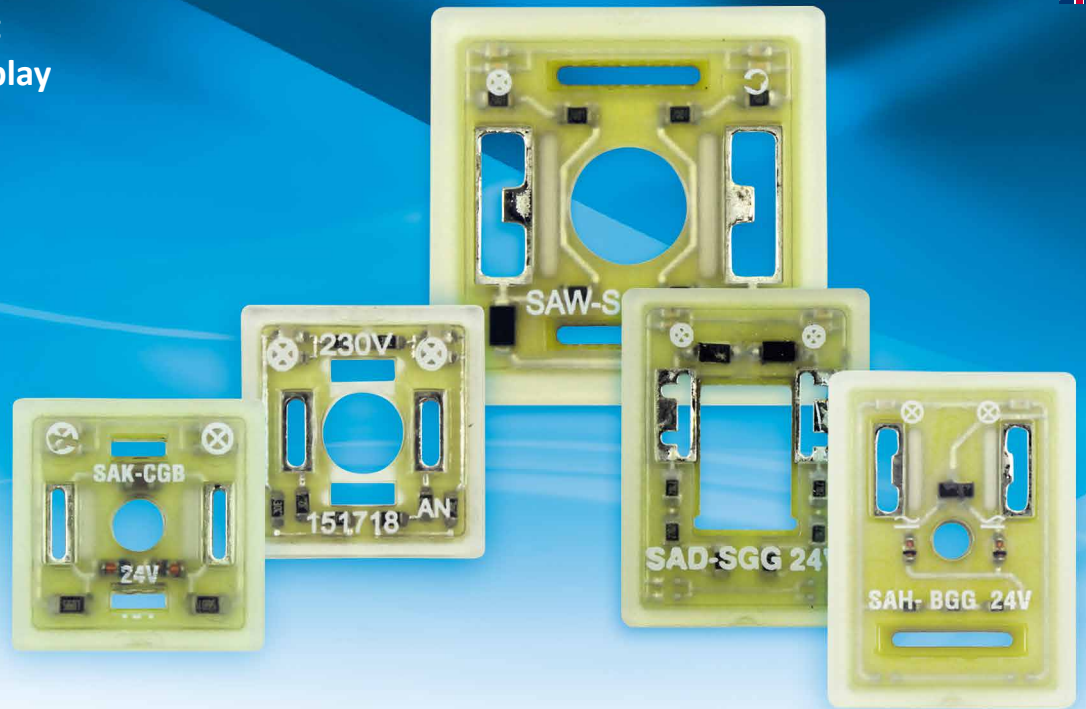

- PUR seals
- Protective circuit
- LED function display



Light Emitting Seals

Lights – Seals – Protects

A defective valve or defective valve coil can damage an entire equipment in a worst case scenario. Control expenditure for all valves in an equipment can be enormous, depending on its size. Staiger's light emitting seals immediately assist you in case of malfunctions as well as precisely detect and eliminate them – without lengthy search times and system failures. Flat light emitting seals can be installed between a valve and its coil in all types of equipment/systems. Their small size and standard connections mean they can be deployed anywhere – even at a later date. Equipment protection and reduction in maintenance time could hardly be easier.

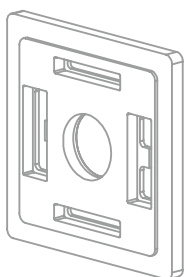

LD-SAW

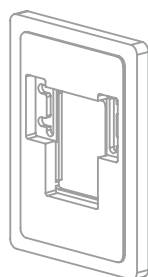

LD-SAD

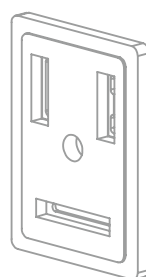

LD-SAH



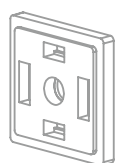

LD-SAB





LD-SAK



Standard Light Emitting Seals

Application	Function	Type	Circuit	Voltage	Solenoid valve power consumption max.	
Solenoid valves with pin-connector DIN EN 175301-803	Size A 	Flat seal with LED	LD-SAW-R	LED	24 V / 48 V / 115 V / 230 V	100 W
		Flat seal with LED and protective circuit	LD-SAW-B	LED and Zener diode	24 V	15 W
	Size B 	Flat seal with LED	LD-SAD-R	LED	24 V / 48 V / 115 V / 230 V	100 W
		Flat seal with LED and protective circuit	LD-SAD-B	LED and Zener diode	24 V	15 W
	Size BI 	Flat seal with LED	LD-SAH-R	LED	24 V / 48 V / 115 V / 230 V	100 W
		Flat seal with LED and protective circuit	LD-SAH-B	LED and Zener diode	24 V	15 W
Size C 	Flat seal with LED	LD-SAB-R	LED	24 V / 48 V / 115 V / 230 V	100 W	
	Flat seal with LED and protective circuit	LD-SAB-B	LED and Zener diode	24 V	15 W	
Size CI 	Flat seal with LED	LD-SAK-R	LED	24 V / 48 V / 115 V / 230 V	15 W	
	Flat seal with LED and protective circuit	LD-SAK-B	LED and Zener diode	24 V	15 W	

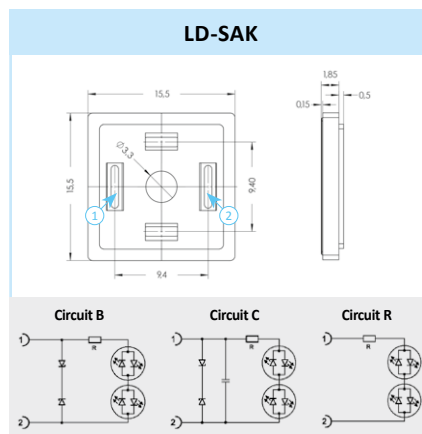
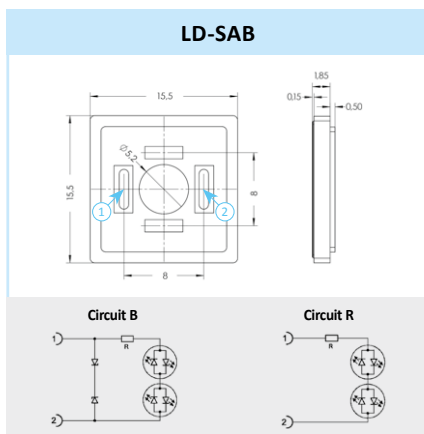
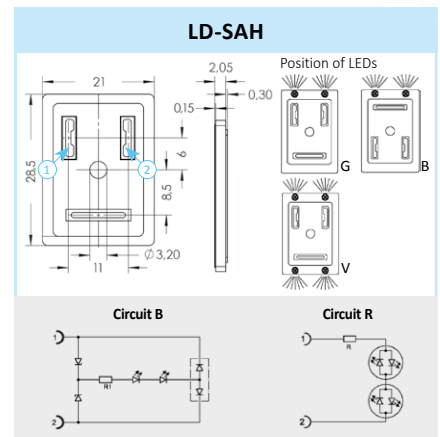
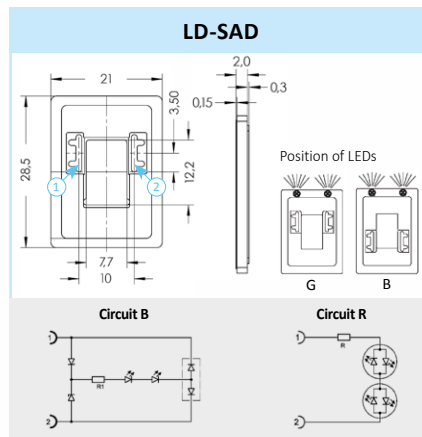
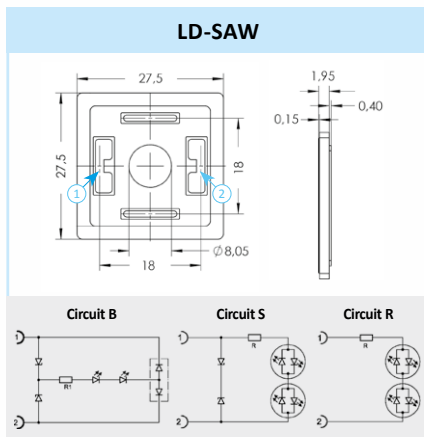
All values were determined under laboratory conditions and have to be verified by the customer for its specific purpose.

PERSONALIZED SERVICE & INDIVIDUAL SOLUTIONS

Phone: +49 (0) 7143 2707-0

We gladly provide you with more information about special designs and customized products according to your demands and standards. We look forward to receiving your request.

E-Mail: sales@staiger.de