

LUMIMAX[®]

Product Overview

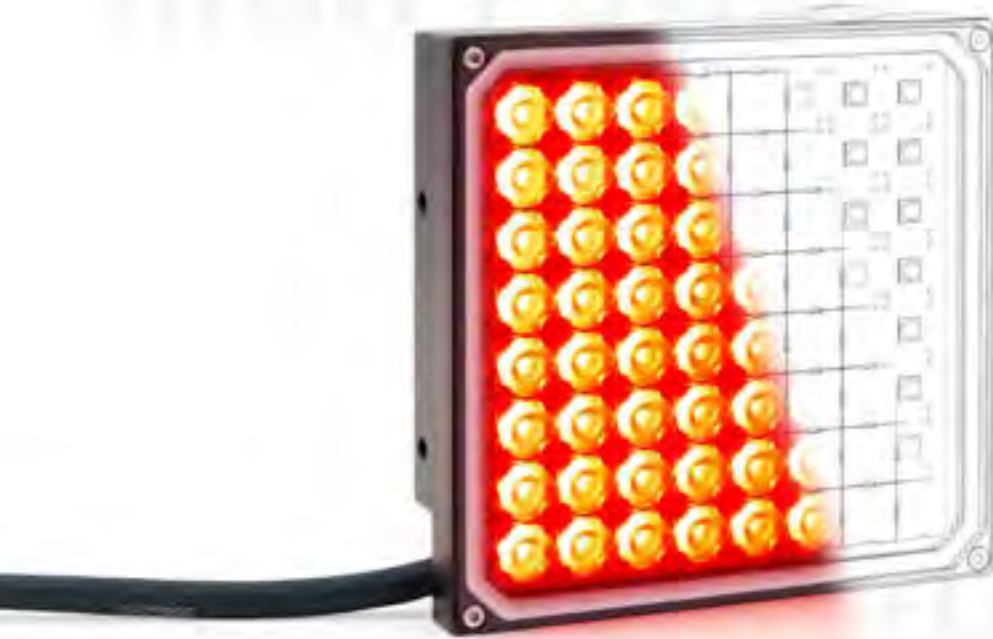









V092021



**POWER
LIGHTS
FOR
MACHINE
VISION**

made by **iim** MEASUREMENT
ENGINEERING in Germany

Contents

LUMIMAX® LED Lighting	4	>
iiM AG - The company	4	>
Service & Support	5	>
Website	5	>
Applications	6	>
LUMIMAX® technology	8	>
Simple integration	10	>
LUMIMAX® High Power Lights		
 LED Area Lights	14	>
 LED Area Flood Lights	16	>
 LED Ring Lights	18	>
 LED Bar Lights	20	>
 LED Spot Lights	22	>
 LED Dark Field Lights	24	>
 LED Dome Lights	26	>
 LED Coaxial Lights	28	>
LUMIMAX® BASIC Lights		
 LED Area Lights	32	>
 LED Ring Lights	32	>



iiM AG - The company

iiM AG measurement + engineering is developer, manufacturer and distributor of high-quality, high-performance products for Machine Vision.

In Suhl (Thuringia), we develop and manufacture high-performance and highly functional LED lights under the LUMIMAX® brand for Machine Vision applications in a very wide range of industrial areas, such as for the automobile, semiconductor, pharma, food, drinks and tobacco industries.

A second division develops and markets special measuring technology and peripherals for the cable and wire industry to record geometric features, particularly on insulating covers and cable sheathing, in accordance with standards.

A team of over 60 engineers, technicians and skilled workers assists our customers as a partner when realising their challenges.

LUMIMAX® LED Lighting

Technology

High-performance lighting products with integrated controller technology for continuous, switch or flashing operation guarantee the utmost functionality and enable the stable, extraneous light-independent illumination of your test objects – even for extremely fast processes. The integration of high-performance LEDs from renowned manufacturers combined with a very wide range of optical systems results in irradiances in new performance classes. Functional accessories and sophisticated connection concepts reduce the time needed to integrate the LED lights into your Machine Vision application.

Quality

Made in Germany – we are committed to the highest level of quality and functionality, guarantee you excellent service, and work with regional partners. All of the development and manufacturing takes place in the head office in Suhl. This means our customers benefit from short processing and delivery times. To ensure the high standard of all processes, the iiM AG quality management system is annually audited by DEKRA Certification GmbH in accordance with standard ISO 9001:2015.

Experience

We have extensive experience in Machine Vision and can apply this knowledge excellently when designing and realising our products and when providing consulting. We see our customers as partners. We thus rely on continuous and close cooperation.



Service & Support

Selecting the right lighting is not only an essential part of stable, reproducible quality control and process control – it is also the key to resolving Machine Vision tasks. What's more, it saves time and money during the planning, start-up and maintenance of Machine Vision solutions in an industrial environment. This is why we guarantee you an extensive range of services in addition to exceptional product quality.

Our team, consisting of technicians and engineers with many years of experience in the field of Machine Vision, is at your disposal at any time for the following services:



- Feasibility studies
- Customer-specific developments & adaptation of products
- Loaned equipment & laboratory equipment
- Consulting and support
- Training



Website

You will find all important information about our products and services on our online portal. Thanks to our **online product configurator**, you can **configure your lighting individually**, view prices and request offers easily. Save your selection in the **wish list** or compare several products quickly and clearly. We also provide options for downloading **data sheets, technical drawings and 3D models as STEP files** directly from the product pages.

Visit us on the internet at:
www.lumimax.com

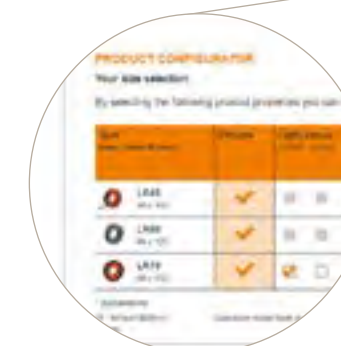

Online product configurator

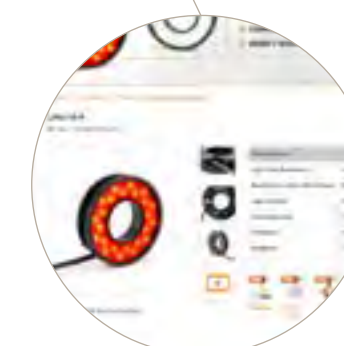

Product detail page



Wish list

Applications

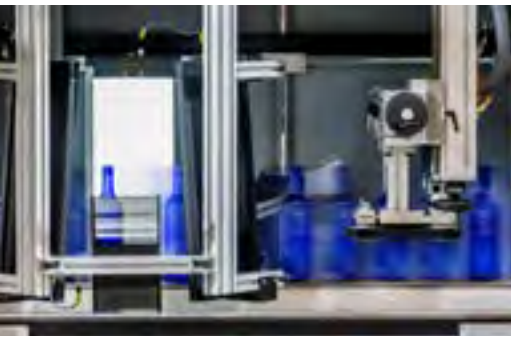

Typical application areas

- Inspection
- Identification
- Measuring
- Verification
- Reading
- Track & Trace
- and much more

Optimization of your Machine Vision Application by LUMIMAX® High Power Lighting

- **Industrial & innovative**
High-quality power LEDs in a functional aluminum housing guarantee optimal temperature management and thus stable light conditions as well as a long service life
- **Speedy and secure**
Reduction of extraneous light and motion blurring due to fast, high-performance flashing
- **Precise & perfect**
Lighting systems and well-suited accessories like filters perfectly fitting to your application
- **Plug & Play**
Fast and simple integration using functional accessories and a standardised connection concept
- **Service & Support**
Feasibility studies by experienced employees and free loaning of components assist you during your realisation phase



© Siemens AG 2016. All rights reserved

Special applications

Standard-compliant reading and verification of codes

Verification and standard-compliant reading is not only used to decipher codes according to standardised processes but also to measure the quality of the code and assess how it can be analysed. The high-quality assessment of the code ensures that this can be read with absolute reliability under unchanged conditions.

To execute the reading and verification process in line with the standards, the lighting situation is determined alongside camera and software factors. A standard-compliant set-up usually requires a 90° viewing angle for the camera and thus the camera must be positioned vertically to the test piece.

Standard-compliant verification of a Data Matrix code



Suitable lightings:
e.g. Dome-, Coaxial-, Mini Bar- and Bar Lights

Fluorescence applications

UV lights are used to make invisible features on products visible. The UV radiation causes certain materials to glow. This glowing is clearly visible to the human eye and cameras.

Product labels that consumers find annoying can be applied with transparent, fluorescent ink. However, under UV radiation, the labelling can be made visible for the purposes of inspection.

Fluorescent, low-contrast adhesives, paints and seals can be shown in high contrast with ultraviolet radiation. Presence and completeness monitoring is thus made easier for the camera.

The finest cracks, such as in cast parts, can be made visible with the aid of fluorescence.

Track & trace in the pharmaceutical industry with UV light



Suitable lightings:
Area-, Ring-, Bar- and Spot Lights

LUMIMAX® technology

Operating modes – continuous, switch or flashing operation

The optimum lighting for every requirement – LUMIMAX® LED Lights are available in continuous, switch or flashing operation.

Continuous and switch mode

Digital TTL and PLC trigger inputs enable synchronised and precise switching of the lights at the time of image acquisition. Because of the low heat development, the short-duration switching considerably increases the service life of the lights.

Flash mode

For synchronized flash mode, LUMIMAX® LED Lights also feature fast and load-free digital TTL and PLC trigger inputs. The flash lights are up to 33 times brighter than the continuous variants. The maximum light output of the lights is available within 3 to 5 µs, guaranteeing extremely short flash times of 10 ... 750 µs with enormous brightness. Motion blurring and extraneous light influences are eliminated.

Benefits of flash lights

- Reduction of motion blurring even with fast-moving processes (up to 100 tests / second)
- Suppression of extraneous light influences
- Increased service life
- Reduction of possible risks to the human eye



Integrated controller

Most LUMIMAX® LED lights have an integrated controller including power electronics. This means that brightness and flash times can be continuously adjusted directly on the lighting. Active reverse polarity protection, integrated ESD protection and EMC shielding guarantee the greatest possible safety. Damage to the lighting by choosing the wrong parameters is almost impossible.

Thanks to the integrated controller technology, even in compact lighting housings, a large part of the electrical power introduced can be converted into light output – there are no losses through long cables between the controller and the lighting.

In addition, the integration into the Machine Vision system is significantly simplified. Additional high-performance power packs are not required.



High Power LEDs

The integration of high-performance LEDs from well-known manufacturers in combination with a wide range of optical accessories enable irradiation intensities in new performance classes for most Machine Vision applications.

LUMIMAX® LED Lights are available in wavelengths ranging from UV365 to IR850.



Designed for industrial use

An aluminium housing with integrated heat management guarantees stable light conditions and a long service life of the light. High protection classes up to IP64 also allow use in very harsh industrial environments. Functional mounting accessories facilitate integration into the Machine Vision application. A highly flexible three-dimensional cable outlet on the latest lighting series simplifies electrical integration of the light.

Flexibility through variation

For a stable and reproducible analysis of Machine Vision applications, an optimum lighting situation is essential. A range of accessory components such as lens kits, lens arrays, diffusing glasses, diffusers and filters allow flexible adjustment of the light direction to the most diverse requirements.

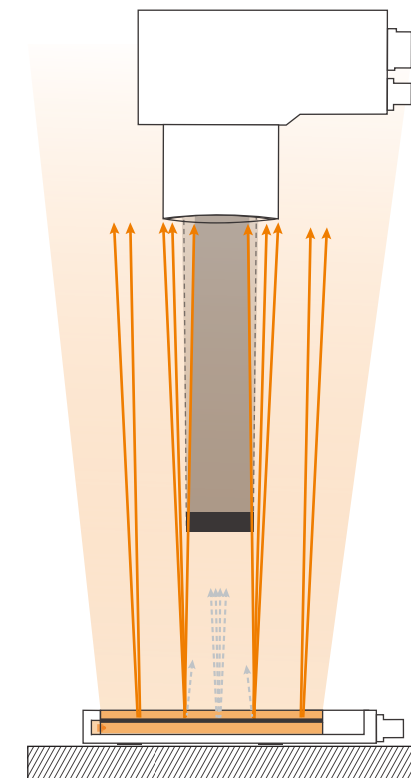

Principle of the LightGuide technology as collimated backlight

LightGuide technology

LUMIMAX® Lights in the LG and LGCB series work with specially manufactured light guides. The light from high power LEDs is inserted in a structure light guide plate and outcoupled either diffused or collimated over the entire light field.

With this new technology, the lights achieve a homogeneity up to 90% over the entire light field.



Simple integration

An extensive range of optical, electrical and mechanical accessories for LUMIMAX® LED Lights simplify both adaptation to customer-specific requirements and the connection to the machine environment. The innovative solutions allow for compact, fast and easy integration of LUMIMAX® LED Lights. This saves additional design and mounting work, which means that significant cost savings can be achieved.

Diffusing glasses, lenses and co.

For a stable and reproducible analysis of Machine Vision applications, an optimum lighting situation is critical. A range of accessory components allow flexible adjustment of the light direction to the most diverse requirements.

Lens kits, lens arrays, diffusers and fresnel lenses enable individual adjustment of the lighting to the working distance and object field.



Changing a lens array of the LUMIMAX® Area Lighting LQHP80



High Power light, above with 49° lenses, below with 10° lenses (at a working distance of 1.5 m)

Optical filters* are used to increase image contrasts in order to suppress extraneous light and minimise disruptive reflections or mirroring.

* You can find more information on optical filters for fluorescence applications in our separate product brochure on the topic of „UV lights“.

Perfectly coordinated filters

High-quality filter combinations coordinated to the application achieve a precise separation of stimulation and emission wavelengths.

UV reflections from the lighting and extraneous light influences are suppressed.

The result: high-contrast fluorescence.

Fast and easy mounting

The LUMIMAX® Mounting Systems allow the direct mounting of the LED light to the camera series, e.g. of Cognex, Baumer, Keyence, SensoPart and Siemens. The mounting variations can be individually adapted and expanded flexibly, so that exact matching of the lighting angle and working distance is guaranteed.



Components for the reading and verification of codes in accordance with the ISO/IEC 15415:2011 /15416:2016 and ISO/IEC 291582020 (DPM) standards

- Direct mounting on the camera system
- Defined swivelling in and out of the light
- Reproducible construction for all reading stations
- Standard-compliant setting of bar lights (e.g. 30° und 45°)

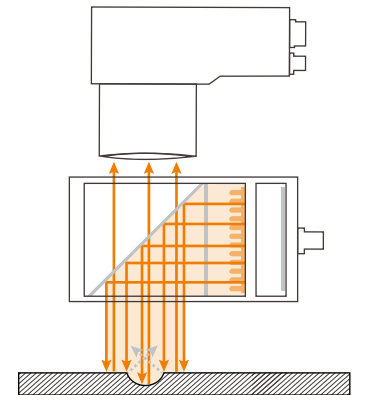

Uncomplicated connections

All LUMIMAX® LED Lights can be put into operation quickly and easily using partly drag chain and robot-compatible cables with standard connectors.

The T-Adapter Cable offers a plug and play solution. The light can be connected directly to the camera system and be controlled by it. This saves additional wiring and simplifies start-up of the components. The adapter cable is located between the camera's electrical connection and the power supply. The light is coupled directly into this signal flow and can get both its power supply and the trigger signal from the camera. The result is a compact, interference-resistant and industry-compatible Machine Vision system.



Standard-compliant arrangement variants via verification adapter for Dome, Coaxial and Bar Lights

LUMIMAX[®]

HIGH POWER



LED Area Lights

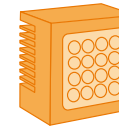

LED Area Flood Lights



LED Ring Lights

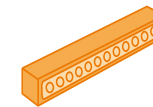

LED Bar Lights

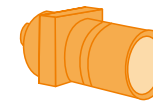

LED Spot Lights



LED Dark Field Lights

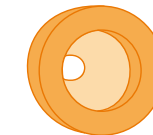

LED Dome Lights



LED Coaxial Lights



LED Area Lights



LUMIMAX® LED Area Lights are for versatile use in all areas of Machine Vision for incident or backlight tasks. Their designs allow for any arrangement around the object to be inspected.

Area Lights in the LG series are based on our LightGuide technology. State-of-the-art LightGuide technology guarantees the maximum degree of homogeneity and irradiance intensity over the entire light field. Variants with additional collimation accessories improve image contrast and minimise the glare effect at manual workstations. The lights can be used with and without a camera hole as incident and backlight.

With the BLACK variant of the LG series, complex Machine Vision solutions based on incident light and backlight can be implemented at the same test station.

The Area Lights of the LQHP series impress thanks to their compact design with integrated, powerful controller technology. With collimated and diffuse light guide, these systems are assigned to Area Lighting. However, due to the modular setup, they can also be easily converted into Area Flood Lights.



Transparent plastic with embossing -
diffuse backlight collimated backlight

Principle

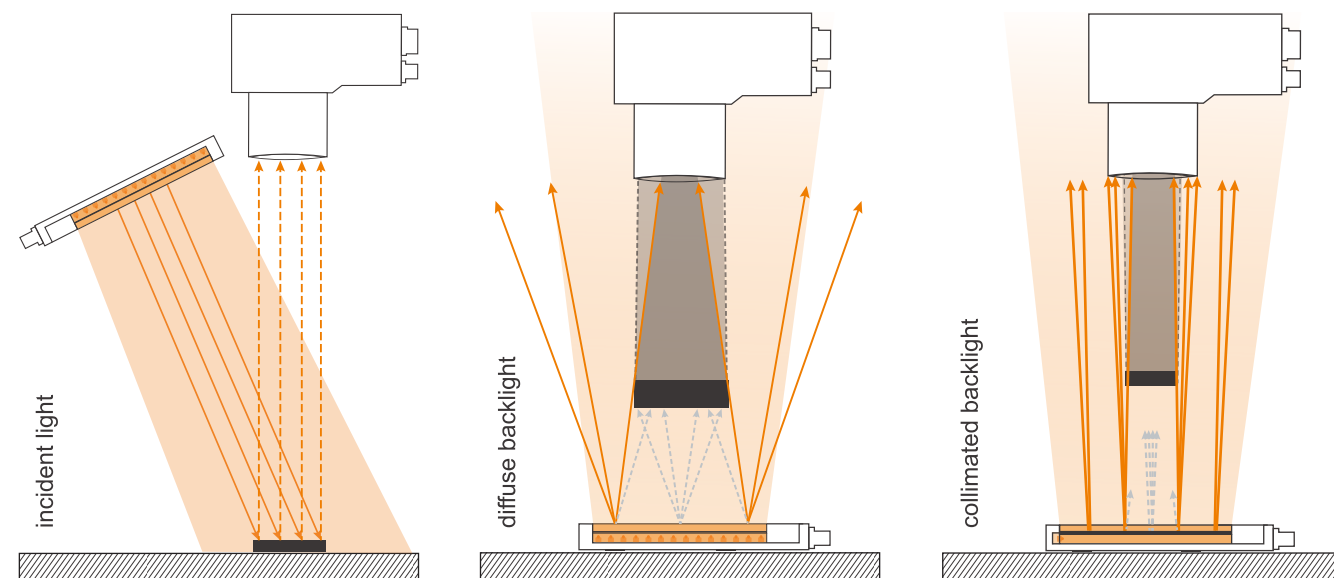

Your benefits at a glance

- **Integrated controller**
Plug & play – extensive parameterisation of the controller is not required. All lights are factory set for maximum performance and safety, guaranteeing stable and long-lasting illumination for your Machine Vision tasks.
- **Flash and continuous mode**
All lights are available in both operating modes. Flash lights allow stable illumination of test objects regardless of interfering light – even in fast moving processes or changing light conditions.
- **High Power LEDs**
The latest generation of high power LEDs guarantee irradiation intensities in new performance classes.
- **LightGuide technology**
The use of special light guides allows homogeneities greater than 90% over the entire light field.
- **High protection class up to IP64**
Lights with high protection classes can also be used in very harsh industrial environments. They are protected against dust, contact and splashing water on all sides.
- **Perfect heat management**
High-quality power LEDs in a functional aluminum housing guarantee optimal temperature management and thus stable light conditions as well as a long service life.

Optional accessories

- T-adapter cables
- Drag chain and robot-compatible cables
- Mounting accessories
- Polarisation filters
- Diffusers

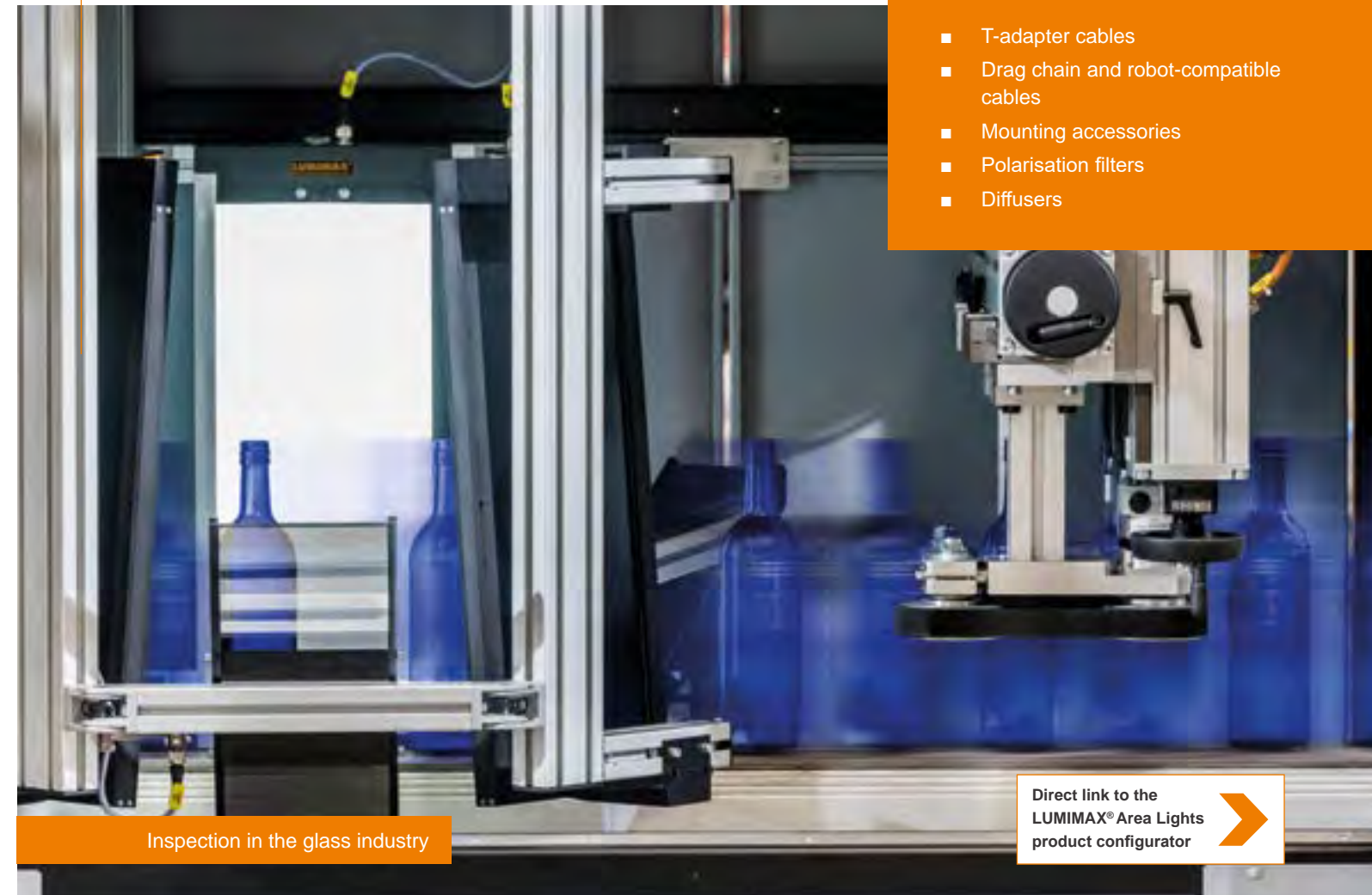

Direct link to the
LUMIMAX® Area Lights
product configurator



LED Area Flood Lights



LUMIMAX® High power LED Area Flood Lights in the LQ series are particularly suitable for tests with large image fields or working distances. The integrated lens exchange option allows the light source to be individually adjusted to different object sizes and working distances. Additional diffusers, fresnel lenses and polarizing filters are available as accessories.

The compact lighting design allows a flexible arrangement on the Machine Vision System. In addition to the usual light colours, the Area Flood Lights are available in the wavelengths UV365 nm and UV400 nm. In combination with coordinated filter systems, they are also suitable for demanding fluorescence applications.

The Area Flood Lights of the LQHP series can be quickly adapted for different applications thanks to the integrated lens arrays. The 3D cable outlet enables individual assembly.

Principle



Your benefits at a glance

- Integrated controller**
 Plug & play – extensive parameterisation of the controller is not required. All lights are factory set for maximum performance and safety, guaranteeing stable and long-lasting illumination for your Machine Vision tasks.
- Flash and continuous mode**
 All lights are available in both operating modes. Flash lights allow stable illumination of test objects regardless of interfering light – even in fast moving processes or changing light conditions.
- High Power LEDs**
 The latest generation of high power LEDs guarantee irradiation intensities in new performance classes.
- Lens exchange option**
 The adjustment of the radiation characteristics of the lights to the image field size or working distance offers maximum flexibility through the exchange of ancillary optics. With the latest lighting series, the exchange of the lenses is even easier – as the lenses are already arranged in a pre-assembled lens array.
- High protection class up to IP64**
 Lights with high protection classes can also be used in very harsh industrial environments. They are protected against dust, contact and splashing water on all sides.
- Perfect heat management**
 An industry-standard aluminium housing with integrated heat management guarantees stable light conditions and a long service life of the light.

Optional accessories

- T-adapter cables
- Drag chain and robot-compatible cables
- Lens kits/ Lens arrays
- Polarisation filters
- Diffusers



Direct link to the
LUMIMAX® Area Flood Lights
product configurator

LED Ring Lights



LUMIMAX® LED Ring Lights are ideal for the uniform illumination of flat, matte and reflective surfaces. Direct mounting on the camera or lens using optional accessories simplifies integration into Machine Vision systems.

Lens exchange options, diffusers, Fresnel lenses and polarisation filters allow the optimisation of the radiation characteristics to the required inspection task – even at working distances of several meters. A range of different sizes and performance classes provide the optimum illumination for every application.

The latest Ring Lights of the LR45 series have a 3D cable outlet for highly flexible integration in very restricted installation surroundings. Thanks to the Lens Array, the radiation characteristics can be quickly adapted to the application.

Principle

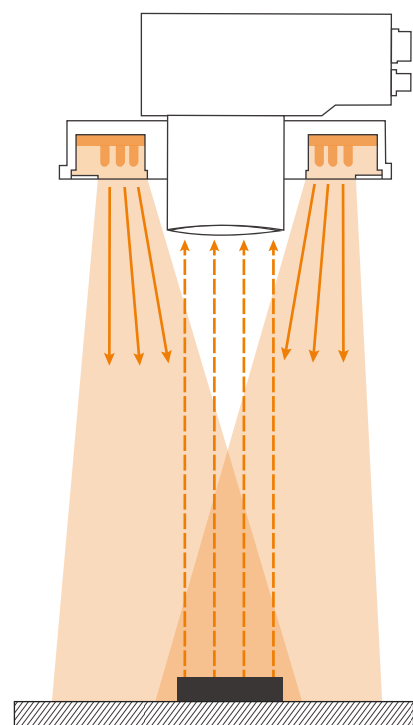

Direct mounting on the camera system



Your benefits at a glance

- **Integrated controller**
Plug & play – extensive parameterisation of the controller is not required. All lights are factory set for maximum performance and safety, guaranteeing stable and long-lasting illumination for your Machine Vision tasks.
- **Flash and continuous mode**
All lights are available in both operating modes. Flash lights allow stable illumination of test objects regardless of interfering light – even in fast moving processes or changing light conditions.
- **High Power LEDs**
The latest generation of high power LEDs guarantee irradiation intensities in new performance classes.
- **Lens exchange option**
The adjustment of the radiation characteristics of the lights to the image field size or working distance offers maximum flexibility through the exchange of ancillary optics. With the latest lighting series, the exchange of the lenses is even easier – as the lenses are already arranged in a pre-assembled lens array.
- **High protection class up to IP64**
Lights with high protection classes can also be used in very harsh industrial environments. They are protected against dust, contact and splashing water on all sides.
- **Perfect heat management**
An industry-standard aluminium housing with integrated heat management guarantees stable light conditions and a long service life of the light.
- **Direct mounting on the camera system**
Well developed options for mounting the lights directly on the Machine Vision system allow fast, space-saving and safe integration. This saves valuable working time.

Optional accessories

- T-adapter cables
- Drag chain and robot-compatible cables
- Mounting accessories
- Lens kits/ Lens arrays
- Polarisation filters
- Diffusers
- Fresnel lenses

Direct link to the
LUMIMAX® Ring Lights
product configurator



LED Bar Lights



The design of LUMIMAX® LED Bar Lights generates the optimum illumination for elongated test objects. With power LEDs in conjunction with interchangeable ancillary lenses, these universal lights are suitable for example for dark field or bright field applications.

The lights in the LB series impress with their enormous irradiation intensities even at large working distances.

Products in the compact LSB series are designed for applications that demand perfect illumination in restricted installation environments. Another special feature is the innovative mounting solution, which allows one to four Bar Lights in the LSB series to be incorporated in the square.

Principle

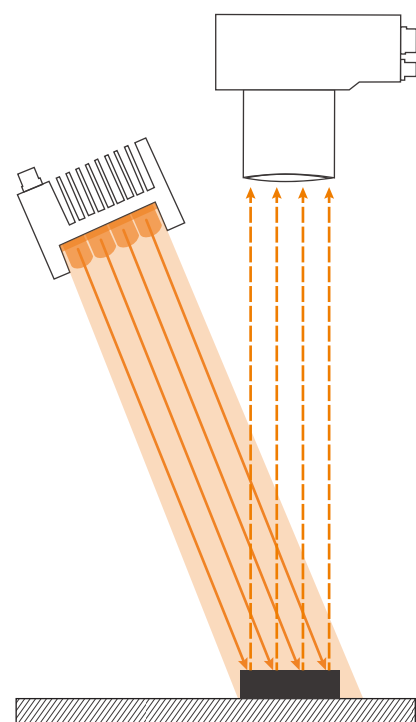

Four-sided mounting bracket for Bar Lights



Verification of Data Matrix codes

Your benefits at a glance

- **Integrated controller**
Plug & play – extensive parameterisation of the controller is not required. All lights are factory set for maximum performance and safety, guaranteeing stable and long-lasting illumination for your Machine Vision tasks.
- **Flash and continuous mode**
All lights are available in both operating modes. Flash lights allow stable illumination of test objects regardless of interfering light – even in fast moving processes or changing light conditions.
- **High Power LEDs**
The latest generation of high power LEDs guarantee irradiation intensities in new performance classes.
- **Lens exchange option**
The adjustment of the radiation characteristics of the lights to the image field size or working distance offers maximum flexibility through the exchange of ancillary optics.
- **High protection class up to IP64**
Lights with high protection classes can also be used in very harsh industrial environments. They are protected against dust, contact and splashing water on all sides.
- **Perfect heat management**
An industry-standard aluminium housing with integrated heat management guarantees stable light conditions and a long service life of the light.
- **Direct mounting on the camera system**
Well developed options for mounting the lights directly on the Machine Vision system allow fast, space-saving and safe integration. This saves valuable working time.
- **Suitable for standard-compliant reading / verification**
With these lights and the recommended accessories, standard-compliant reading or verification units can be achieved quickly and reproducibly.

Optional accessories

- T-adapter cables
- Drag chain and robot-compatible cables
- Mounting accessories
- Lens kits
- Polarisation filters
- Diffusers
- Verification adapters

Direct link to the
LUMIMAX® Bar Lights
product configurator



LED Spot Lights



LUMIMAX® LED Spot Lights are particularly compact, but at the same time extremely powerful and versatile.

Adjustable precision optics allow adjustment of the radiation characteristics to the required working distances and image fields, enabling a focused or very homogeneous illumination of the object to be inspected. With the C-Mount connector, either integrated or available as an accessory, lenses for focusing can be used. A filter thread allows mounting of components such as polarisation filters or bandpass filters for fluorescence applications.

Despite their compact design, the LUMIMAX® LED Spot Lights feature an integrated lighting controller for continuous or flash mode.

Principle

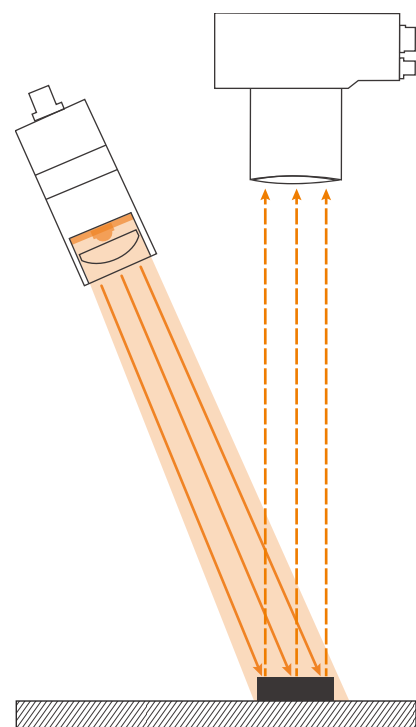

Direct mounting of the Spot Light on the camera system

Your benefits at a glance

- **Integrated controller**
Plug & play – extensive parameterisation of the controller is not required. All lights are factory set for maximum performance and safety, guaranteeing stable and long-lasting illumination for your Machine Vision tasks.
- **Flash and continuous mode**
All lights are available in both operating modes. Flash lights allow stable illumination of test objects regardless of interfering light – even in fast moving processes or changing light conditions.
- **High Power LEDs**
The latest generation of high power LEDs guarantee irradiation intensities in new performance classes.
- **Adjustable optics**
Continuously adjustable optics allow the individual adjustment of the lighting to different requirements.
- **Filter thread**
Whether it's a polarisation or colour filter – the thread allows direct mounting on the light.
- **C-Mount connector**
The C-Mount connector, with its use of lenses for focusing, offers unlimited variability.
- **High protection class up to IP64**
Lights with high protection classes can also be used in very harsh industrial environments. They are protected against dust, contact and splashing water on all sides.
- **Perfect heat management**
An industry-standard aluminium housing with integrated heat management guarantees stable light conditions and a long service life of the light.
- **Direct mounting on the camera system**
Well developed options for mounting the lights directly on the image processing system allow fast, space-saving and safe integration. This saves valuable working time.

Optional accessories

- T-adapter cables
- Drag chain and robot-compatible cables
- Mounting accessories
- C-Mount adapters
- Polarisation filters
- High, short and bandpass filters

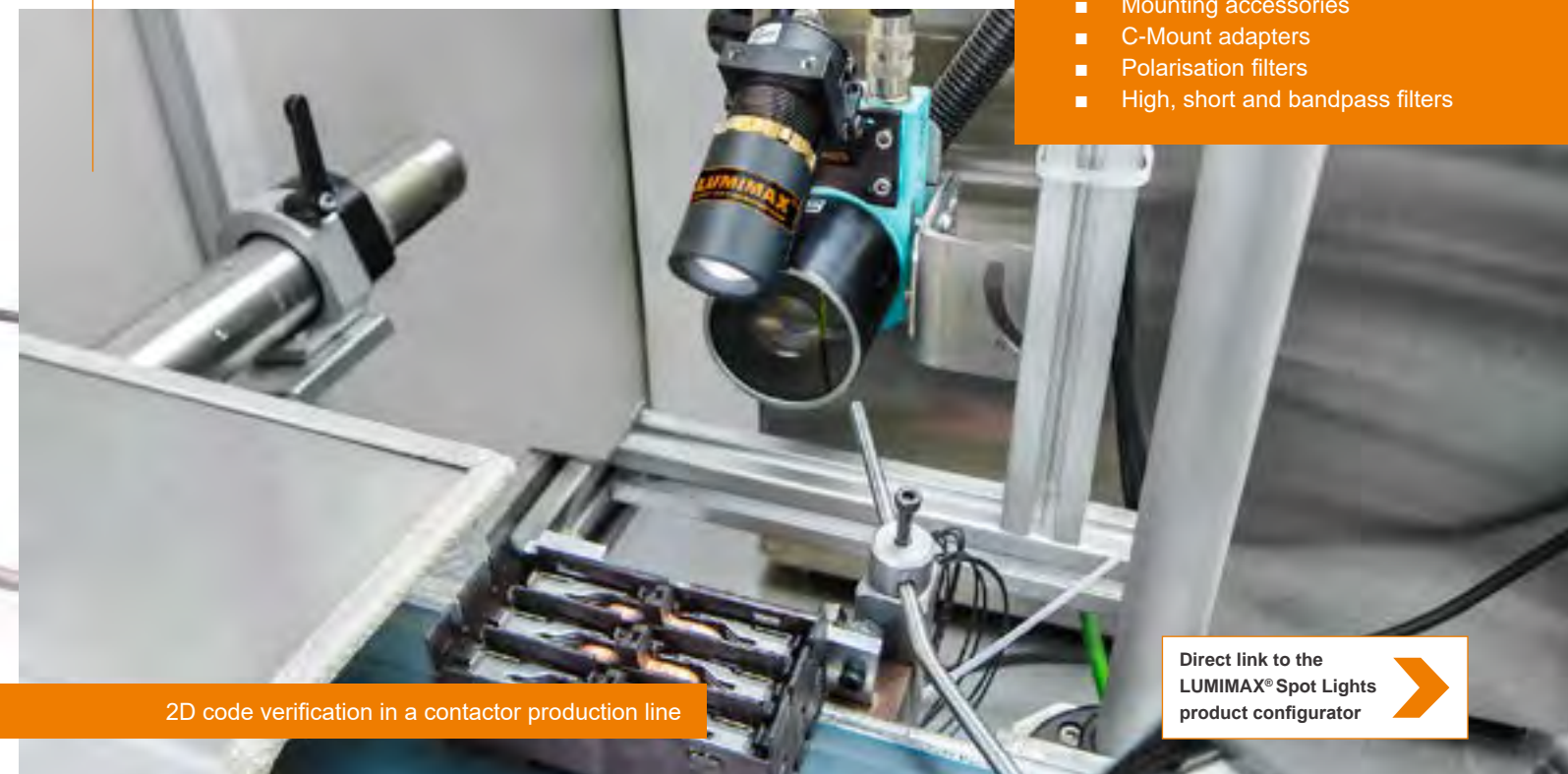

2D code verification in a contactor production line

Direct link to the
LUMIMAX® Spot Lights
product configurator



LED Dark Field Lights



With their radial and flat incoming light, LUMIMAX® LED Dark Field Lights are the preferred option for inspecting surfaces. Their special light guide means that this illumination geometry can be used to show edges, cavities and other surface defects in high contrast.

The lights in the DFL series are available in several sizes for continuous and flash mode.

Integrated controllers, powerful LEDs and standardised LUMIMAX® connections guarantee simple and stable integration into the system environment.

Principle

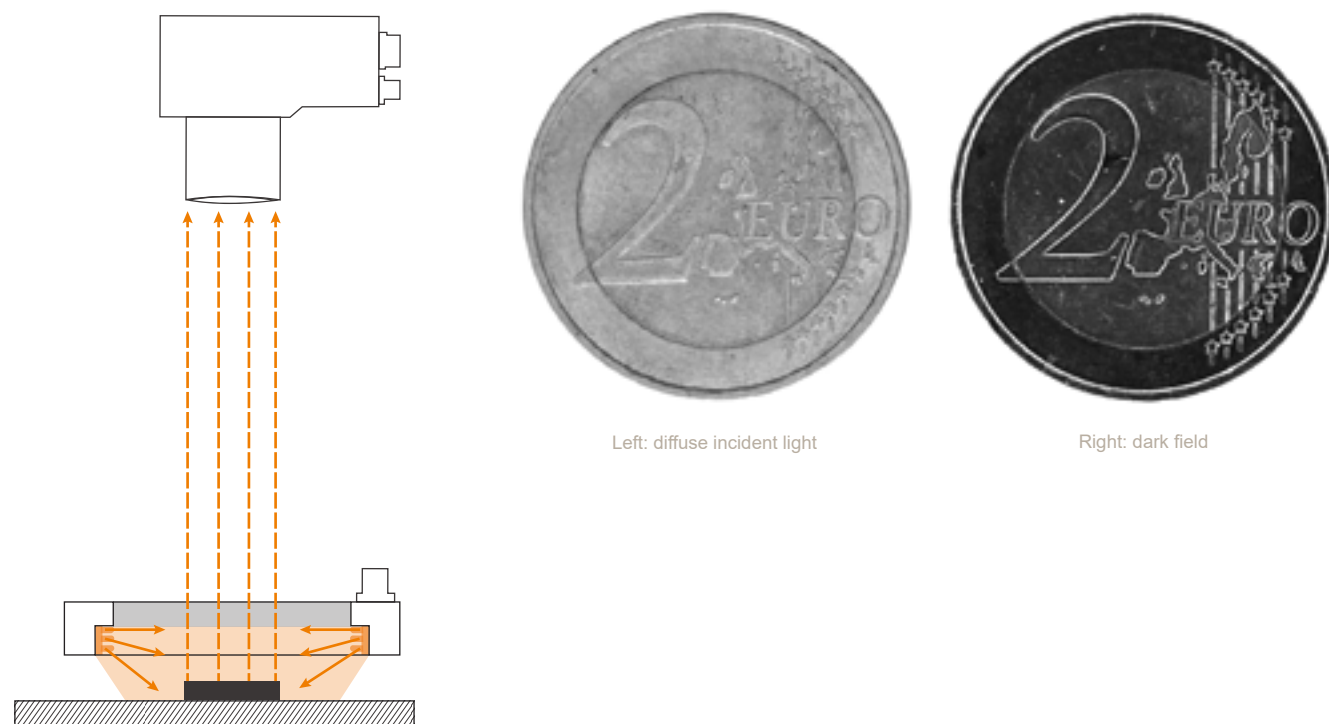

Your benefits at a glance

■ Integrated controller

Plug & play – extensive parameterisation of the controller is not required. All lights are factory set for maximum performance and safety, guaranteeing stable and long-lasting illumination for your Machine Vision tasks.

■ Flash and continuous mode

All lights are available in both operating modes. Flash lights allow stable illumination of test objects regardless of interfering light – even in fast moving processes or changing light conditions.

■ Perfect heat management

An industry-standard aluminium housing with integrated heat management guarantees stable light conditions and a long service life of the light.

Optional accessories

- T-adapter cables
- Drag chain and robot-compatible cables



LED Dome Lights



With their domed shape, LUMIMAX® LED Dome Lights generate a diffused light that falls on the test object from all directions, achieving completely shadow-free illumination.

Typical applications are the inspection of reflective or mirroring materials. With a Dome Light, even complex or curved surfaces can be illuminated homogeneously.

Dome Lights are extremely well suited for standard-compliant reading and verification of two-dimensional codes.

Principle

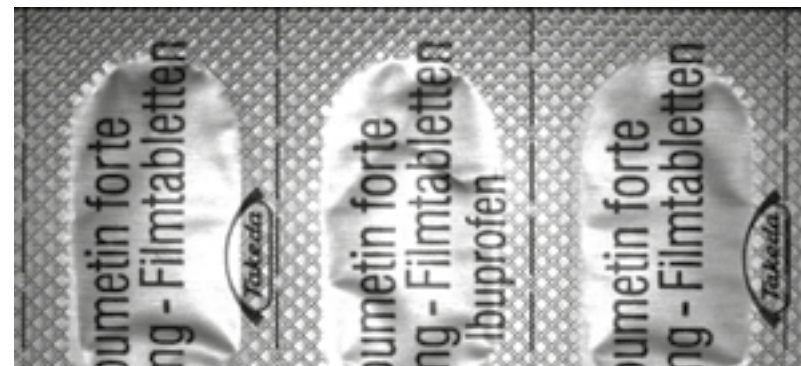
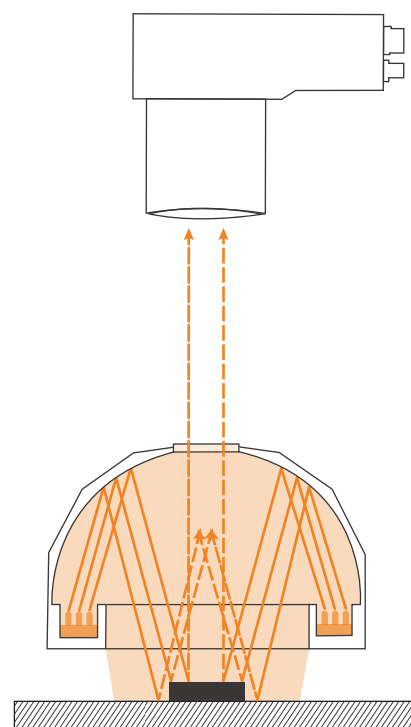

Back of a tablet blister – incident light

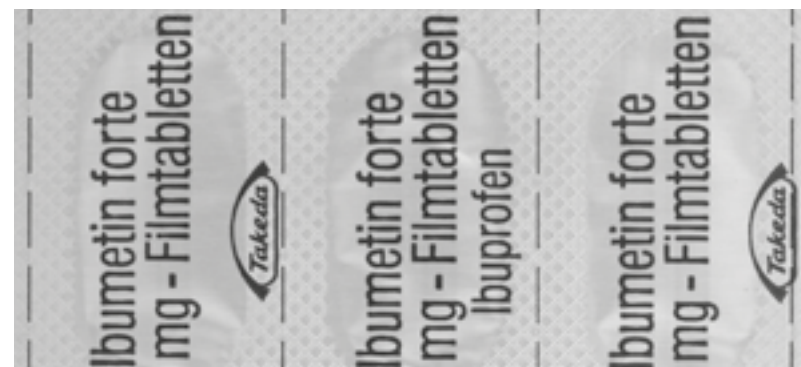

Back of a tablet blister – dome light

Your benefits at a glance

- **Flash and continuous mode**
All lights are available in both operating modes. Flash lights allow stable illumination of test objects regardless of interfering light – even in fast moving processes or changing light conditions.
- **Suitable for standard-compliant reading / verification**
With these lights and the recommended accessories, standard-compliant reading or verification units can be achieved quickly and reproducibly.
- **Perfect heat management**
An industry-standard aluminium housing with integrated heat management guarantees stable light conditions and a long service life of the light.
- **Direct mounting on the camera system**
Well developed options for mounting the lights directly on the Machine Vision system allow fast, space-saving and safe integration. This saves valuable working time.

Optional accessories

- Controllers for continuous or flash mode
- T-adapter cables
- Drag chain and robot-compatible cables
- Verification adapters



Standard-compliant verification of a Data Matrix code

Direct link to the
LUMIMAX® Dome Lights
product configurator

LED Coaxial Lights



With LUMIMAX® LED Coaxial Lights, a highly diffused light field is shown on the object field through a semi-transparent mirror vertical in the optical axis of the camera.

With very homogeneous and shadow-free illumination, Coaxial Lights are used for surface inspections, completeness checks and print inspections.

These Lights also meet the requirements for standard-compliant reading and verification of two-dimensional codes.

Principle

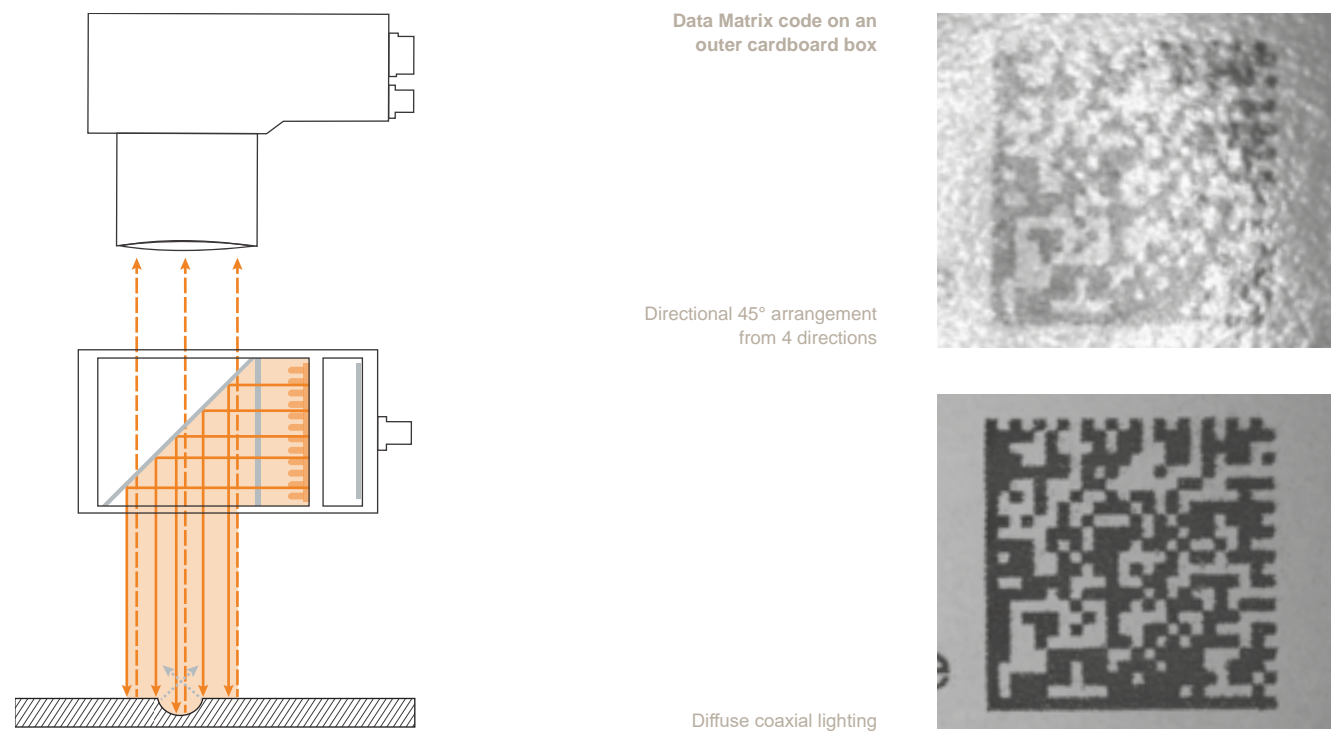

Your benefits at a glance

- **Integrated controller**
Plug & play – extensive parameterisation of the controller is not required. All lights are factory set for maximum performance and safety, guaranteeing stable and long-lasting illumination for your Machine Vision tasks.
- **Flash and continuous mode**
All lights are available in both operating modes. Flash lights allow stable illumination of test objects regardless of interfering light – even in fast moving processes or changing light conditions.
- **Power LEDs**
The latest generation of high power LEDs guarantee irradiation intensities in new performance classes.
- **Suitable for standard-compliant reading / verification**
With these lights and the recommended accessories, standard-compliant reading or verification units can be achieved quickly and reproducibly.
- **Perfect heat management**
An industry-standard aluminium housing with integrated heat management guarantees stable light conditions and a long service life of the light.
- **Direct mounting on the camera system**
Well developed options for mounting the lights directly on the Machine Vision system allow fast, space-saving and safe integration. This saves valuable working time.

Optional accessories

- T-adapter cables
- Drag chain and robot-compatible cables
- Verification adapters



LUMIMAX[®] BASIC



LED Area Lights

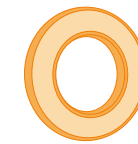

LED Ring Lights



BASIC Area and Ring Lights



The LUMIMAX® BASIC series are the ideal choice for use in simple Machine Vision applications. The reduction to essential functions and the absence of changeover options and extensive accessories allow acquisition costs to be optimised while maintaining high quality and reliability.



Your benefits at a glance

- Flash and continuous mode**
 The lights in the BASIC series can be synchronised and precisely switched thanks to digital, load-free SPS trigger inputs. Flash mode is available by using an external flash controller.
- Designed for industrial use**
 Aluminium housings with highly flexible 3D cable outlets and a standardised BASIC connection concept allow the lights to be easily integrated into industrial Machine Vision systems.
- High protection class**
 The BASIC series can also be used in very harsh industrial environments thanks to IP64. They are protected against ingress of dust and spray water.
- Compact design**
 The sizes of the BASIC lights are kept to a minimum so that they can even be used where conditions offer very little space for installation.

BASIC Area Lights



Direct link to the LUMIMAX® BASIC Area Lights product configurator

The Area Lights in the BF series are for versatile use in all areas of Machine Vision. One version with a directed distribution of light (30° LED beam angle) can be used for reflected light applications. A highly diffused version is available for backlight applications.

Principle

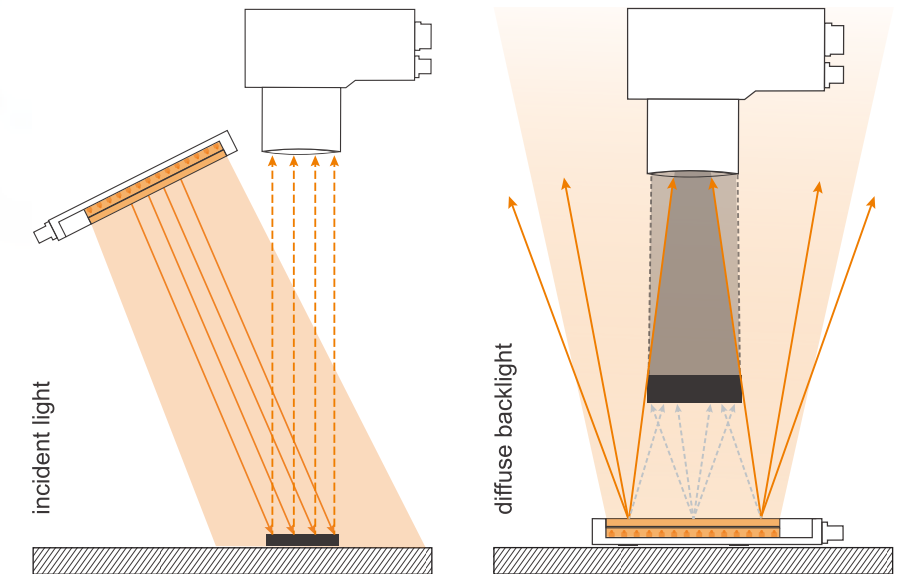

BASIC Ring Lights



Direct link to the LUMIMAX® BASIC Ring Lights product configurator

The Ring Lights in the BR series can be used for the uniform illumination of plane, matte and reflective surfaces in reflected light applications. All four sizes of these Ring Lights can be combined to create one large light field without significant mechanical delimitations.

Principle

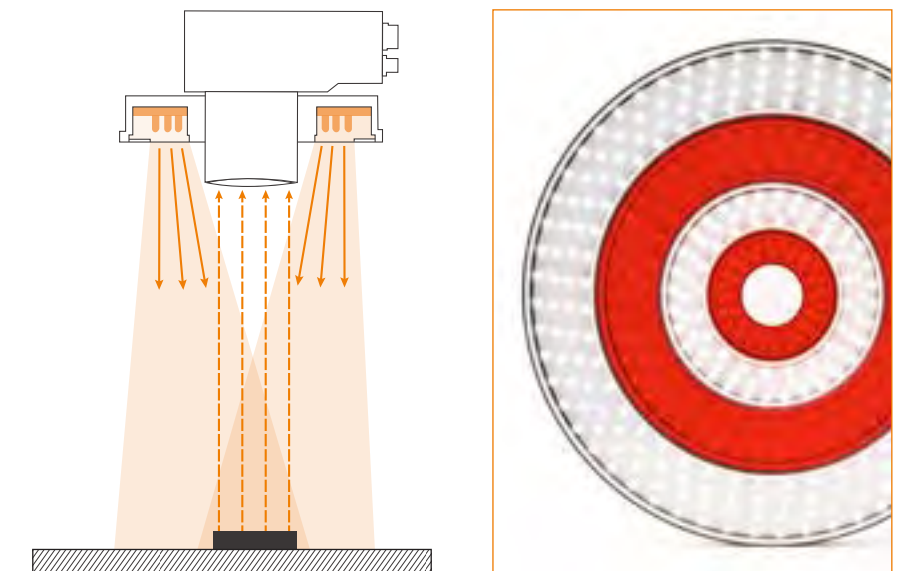

Contact

iiM AG measurement + engineering
Neuer Friedberg 5
DE-98527 Suhl

Phone: (+49) 3681 / 455 19-0
Fax: (+49) 3681 / 455 19-11
Web: www.iiM-AG.com
E-Mail: info@iiMAG.de

www.lumimax.com