

MP150

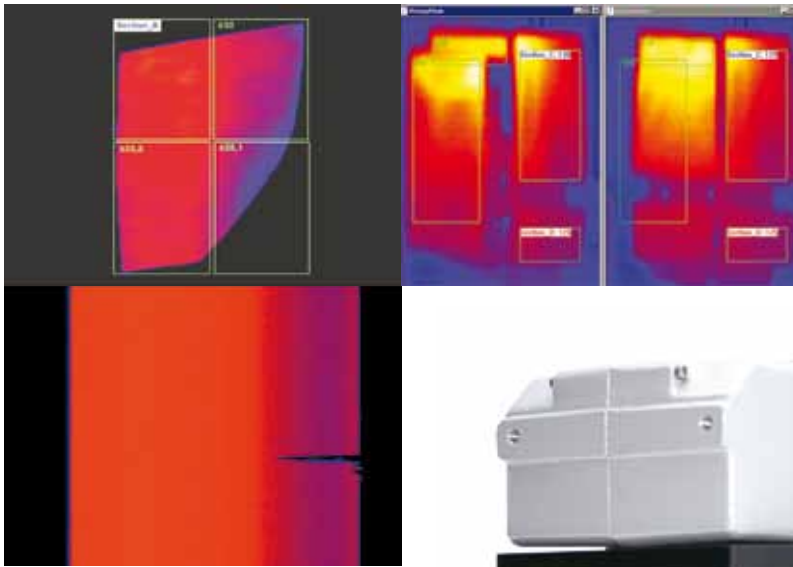

Thermal Imaging for Industrial Applications



MP150 Linescanner

MP150 Linescanner with DataTemp® DP Software



The most widely used solution for real-time process temperature imaging and analysis

- Fast scan speed up to 150 lines per second
- Up to 1024 measurement points per line
- High optical resolution up to 200:1
- Real-time colour thermal images
- Accurate data analysis
- Reliable Ethernet Communication
- Rugged, waterproof housing
- 40,000 MTB brushless scanning motor
- Field-replaceable window
- Built-in air purge and water cooling

The MP150 Linescanner Series is a family of advanced infrared linescanners providing accurate, real-time, thermal imaging for a wide variety of industrial applications, including continuous sheet and web-based processes, discrete manufacturing processes, and rotating kilns.

The MP150 is surprisingly easy to install and manage. Pre-wired cables allow for fast, easy installation and connection to a standard PC. Many installations require less than an hour from start to finish. Versatile DataTemp DP Software allows custom configuration of MP150 operating parameters and display of thermal images and temperature profiles. The MP150 is designed for reliability and continuous operation in harsh industrial environments. The MP150's rugged housing includes built-in provisions for water-cooling and air-purge.

Offering best-value performance, the MP150 is the most widely used linescanner worldwide. Additional application-specific systems based on MP150 Linescanner feature dedicated hardware and software for specialized applications such as rotating kilns, wallboard, thermoforming, and glass bending/tempering and plastic extrusion processes.

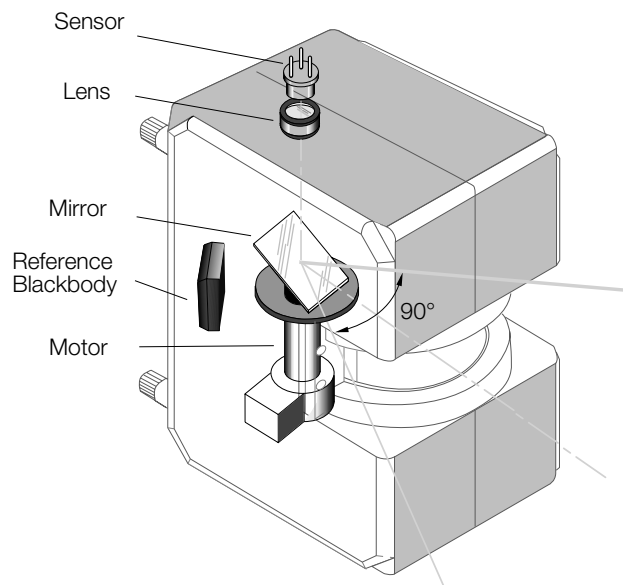

The MP150 contains the scanning mechanism, infrared detector, optics, signal processing electronics, electrical inputs/outputs, and data communications.

MP150 Models



MP150 models are available with a choice of temperature and spectral ranges including special models for plastics, glass, and metals. The P3 model ensures uniform temperature measurement for thin-film plastic applications. The G5 model ensures process quality on flat glass, glass wind-

shields, and tempering lines.

The 1M model measures metal surface temperatures and in a way that allows the imager to be safely mounted away from hot targets.

Model Number	Temperature Range Standard Models*	Typical Applications
RAYTMP150LT	20 – 350°C	Printing, coating, laminating, food, drying/curing, thermoforming textiles, plaster board, paint curing, carpeting, and flooring
RAYTMP150MT	100 – 800°C	Heat treating, ore processing
RAYTMP150HR	100 to 650°C	Kiln shell temperatures, hot clinkers, hot spot detection on conveyor belts
RAYTMP150G5	100 – 950°C	Surface temperature measurement for sealing, laminating, bending
RAYTMP150P30	30 – 250°C	Extrusion and converting of polyethylene, polypropylene, and polystyrene thin films
RAYTMP150P31	100 – 350°C	Extrusion and converting of polyethylene, polypropylene, and polystyrene thin films
RAYTMP1501M	600 – 1200°C	Hot strip mills, plate mills, and continuous casting
RAYTMP1502M	400 – 950°C	Hot strip mills, plate mills, and continuous casting

*For measuring temperatures up to 3000°C, please ask your Raytek Sales contact.

Edge-to-edge Temperature Measurement

Unlike point sensors that measure a single point, the MP150 measures multiple temperature points across a scan line. The MP150's motorized mirror scans at rates up to 150 lines per second. The faster scan rate allows rapid detection of temperature non-uniformities and hot spots. Rotating optics collect infrared radiation at 1024 points within a 90° field of view. A two-dimensional image is formed as the material moves across the MP150's field-of-view.

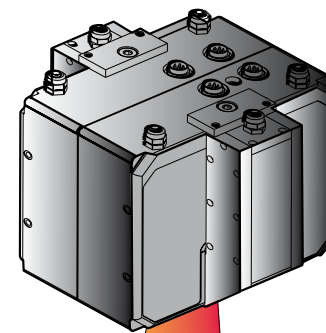

DTDP Software

Imaging

Real-time thermal imaging is provided by DataTemp DP Windows® software for temperature monitoring, display, and analysis. With DataTemp DP, you can quickly detect a hot spot or non-uniformity before it becomes a problem. Simultaneously view cross-machine temperature profiles, contour graphs, and thermograms in multiple windows. Select a portion of the thermal image and zoom in for a more detailed view. Or, compare a stored reference image with the current image to ensure consistency. The familiar Windows® interface makes DTDP intuitive and easy to use.

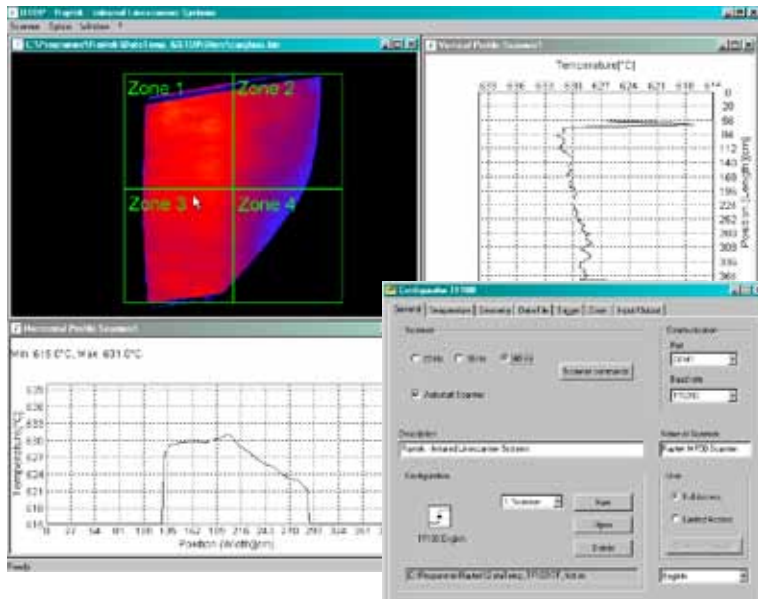

The easy-to-use Windows software display can be customized to meet your process control requirements.

Alarming

The DTDP software provides features to sub-divide thermal images from MP150 into portions of specific interest. Temperatures in each portion can be processed for a certain math function like average, maximum, or minimum temperatures. In case of a thermal defect, the software triggers an alarm. For later analysis, the thermal image is automatically stored in a separate file. The alarm can also be output with an optional digital output module.

Interfacing

For interfacing to other control systems, temperature values can be made accessible in a network via an OPC or DDE server. In addition, it is also possible to output temperature values as current or voltage by means of additional hardware output modules or alternatively by using a standard serial COM port of a PC.

The OPC server provides an interface to DTDP software from OPC-compatible clients complying with the OPC software interface standard. This allows DTDP to function as an OPC server to enable communication of temperature data to third-party HMI/MMI programs. OPC can also provide a straightforward and flexible interface to user-developed software. OPC facilitates the transfer of temperature data into spreadsheets (like MS-Excel), custom OEM applications, and history files.

Features

- View two-dimensional thermal images, temperature profiles and difference images
- Define product-specific configurations
- Analyze temperatures automatically (Minimum, Maximum, Average, ...)
- Fail-safe alarm logging
- Define a reference image display
- Playback stored thermal images as a movie
- System interfaces include OPC or DDE server, analogue/digital output modules, or a serial COM port
- Supports multiple MP150 Linescanners
- Specify security passwords and access levels
- Multiple language support

Application Specific Systems based on DTDP Software

Raytek offers customized process imaging systems to meet specific application requirements for kiln shell monitoring, gypsum wallboard production, thermoforming machine control, extrusion coating, and glass processing:

The **CS210** System is a comprehensive temperature measurement system for monitoring, control, and analysis of rotating kiln shells used in cement and lime production, preventing costly kiln damage and extending production runs.

The **TF150** System allows thermoformers to visualize temperature distribution of plastic parts in thermoforming processes, reducing scrap and improving product quality.

The **GS150/GS150LE** System allows glass manufacturers to measure temperature distributions for glass annealing, glass tempering, and glass bending operations, even for Low-E glass.

EC150 Thermal imaging and analysis for real-time defect detection and quality improvement of plastic extrusion, coating, and lamination processes.

ES150 continuously monitors web processes, for example hot rolling mill or paper drying.

The **TIP450** System performs detailed wallboard dryer balance analysis and board thermal mapping which results in board quality improvements, production increases, fuel savings, defect detection and rework, and manpower reductions.



The rugged cooling housing protects the MP150 Linescanner.

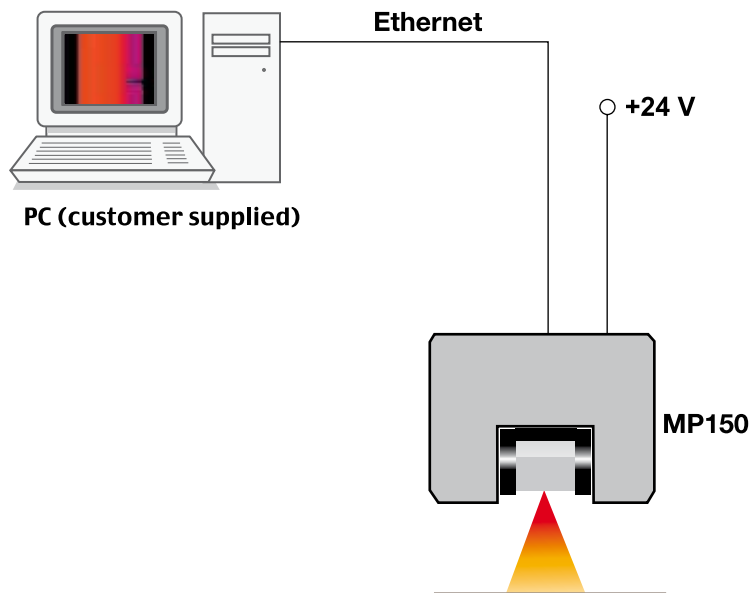

Easy Installation

The small size of the MP150 Linescanner allows for trouble-free installation. The MP150 connects to a standard PC operating Windows. The Ethernet interface insures fast and reliable data transmission to the PC. The diagram above represents a typical installation.

Linescanner Package

RAYTMP150	- MP150 Linescanner* with internal line laser
	- Cables for power supply, Ethernet
	- Support Software
	- Documentation

*See *MP150 Datasheet* for further information.

Accessories

Part Number	Description
XXXTMP150ACCC	MP150 carrying case
XXXTMP50ACRMB	Adjustable mounting base
XXXTMP150CERT	Calibration certificate
XXXETHBASICKIT	Ethernet Fieldbus Coupler
XXXETH2R	Relay Output Module
XXXETH2AOC4	Analog Output Module
XXXETH16DO	Digital Output Module
XXXTMP150FS...	Fittingset Cooling
XXXHSFIKIT	Fiber Optic Converter Kit
XXXTMP50THERM	Thermostat for linescanner

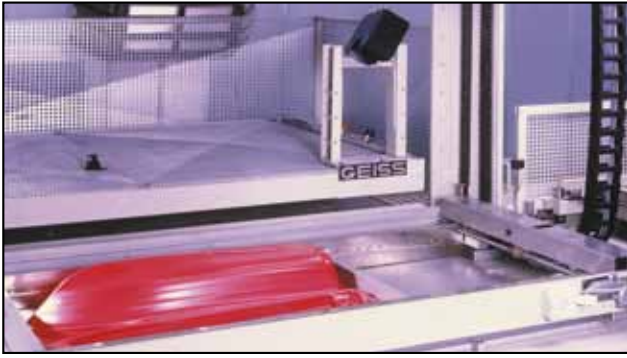

The TF150 System profiles a thermoformed plastic sheet to ensure proper and uniform temperature distribution.

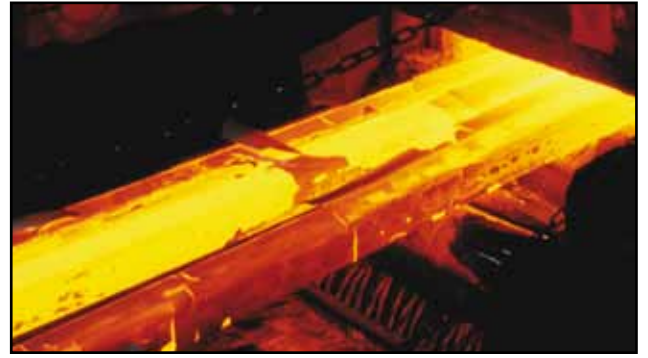

Accurate temperature measurement of slabs, billets, or blooms on a hot rolling mill with ES150 System ensures product uniformity.



Monitoring edge temperature with EC150 reduces scrap and ensures proper film temperatures for strong film-to-paper adhesion.



The GS150 System is an automated infrared temperature measurementsystem for glass bending, forming, annealing, and tempering processes.

Fluke Process Instruments

Americas

Santa Cruz, CA USA
Tel: +1 800 227 8074 (USA and Canada, only)
+1 831 458 3900
solutions@flukeprocessinstruments.com

EMEA

Berlin, Germany
Tel: +49 30 4 78 00 80
info@flukeprocessinstruments.de

China

Beijing, China
Tel: +8610 6438 4691
info@flukeprocessinstruments.cn

Japan

Tokyo, Japan
Tel: +81 03 6714 3114
info@flukeprocessinstruments.jp

Asia East and South

India Tel: +91 22 2920 7691
Singapore Tel: +65 6799 5578
sales.asia@flukeprocessinstruments.com

Worldwide Service

Fluke Process Instruments offers services, including repair and calibration. For more information, contact your local office.

www.flukeprocessinstruments.com

© 2016 Fluke Process Instruments
Specifications subject to change without notice.
10/2016 55511G

