

MOULDER HEAD - PREMIUM LINE

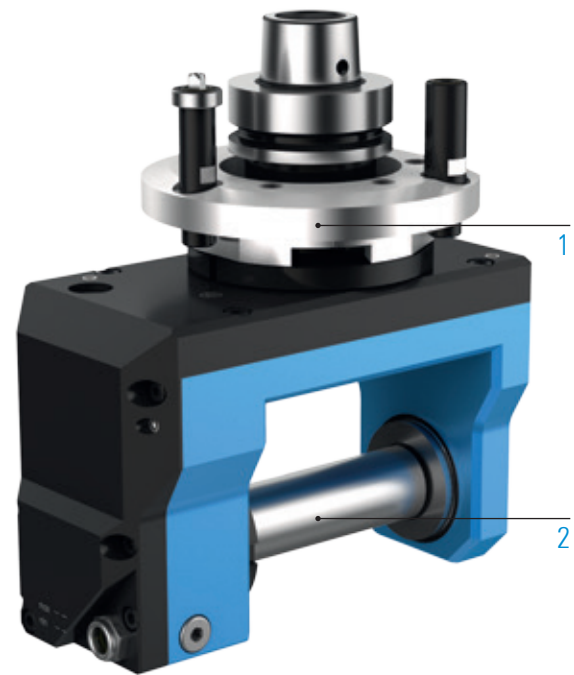

MOULDER C

TECHNICAL DATA



Lubrication	Oil bath
Max. drive speed n_2	10,000rpm
Transmission ratio ($n_1: n_2$)	1:0.9
Max. drive torque M_2	25Nm
Weight	about 7.5kg
Max. tool diameter	Ø125

STANDARD DESIGN

- 1  Machine connection
HSK - F63
- 2  Output spindle
Arbor Ø30, tool length 100 mm

ADDITIONAL OPTIONS: MODULAR DESIGN



MACHINE CONNECTION



i For further information see p. 106

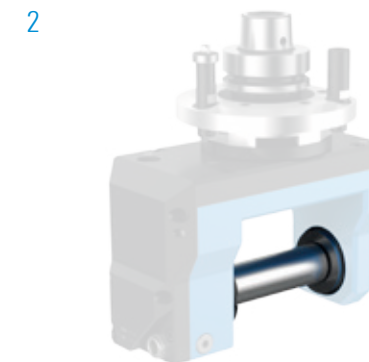



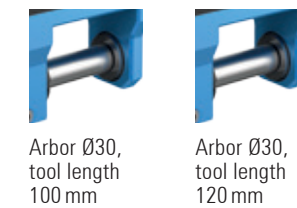

OUTPUT SPINDLE







i Additional arbor diameters and tool lengths on request

MACHINING

-  Milling
-  Sawing
-  Planing
-  Brushing

SPECIFICATIONS

-  Number of output spindles
-  Axis angle
-  C-angle
-  Oil bath lubrication

VIDEO

 Unit - live in the application
Scan QR code or go to:
www.youtube.com/BENZWerkzeugsysteme

ORDER DIRECTLY

 Inquiry form:
www.benz-tools.de/en/products