

交流3芯连接器I

AC3C Connector I

产品规格

Product Specifications

绝缘材料 Insulation material	PPE/PA	安全等级 Safety degree	II
额定电流 Rated current	Max.35A(6sqmm)	阻燃等级 Flame class	UL94-V0
额定电压 Rated voltage	500V AC	电线最大外径 Suitable cable OD Max.	Φ21mm
测试电压 Test voltage	4kV	环境温度范围 Ambient temperature range	-40°C...+85°C(IEC)
连接器接触电阻 Typical contact resistance	≤0.25 mΩ	适配电线规格 Suitable cable cross sections	1.5~6mm ² /16~10AWG
金属导体材料 Contact material	铜,镀锡 Copper, Tin plated	连接方式 Connecting system	锁/铆接方式 Screw/crimping connection
保护等级 Degree of protection	IP67	绝缘电阻 Insulation resistance	≥ 1000 MΩ
连接端子的直径及数量 Contaction diameter/number of contact	Ø2.6x3	标准 Standard	EN 61984

线端母头-板端公头:

Cable female-panel male:

线端母连接器

Female cable end part number:3PCF1-6

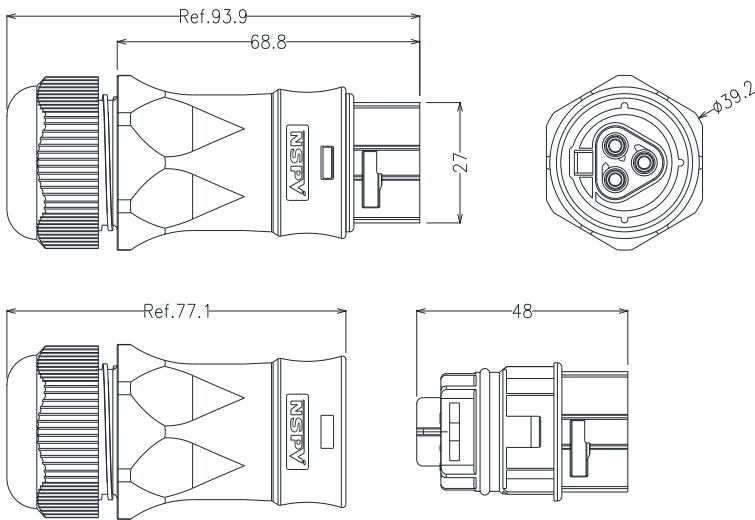

板端公连接器

Male panel connector:3PPM1-6

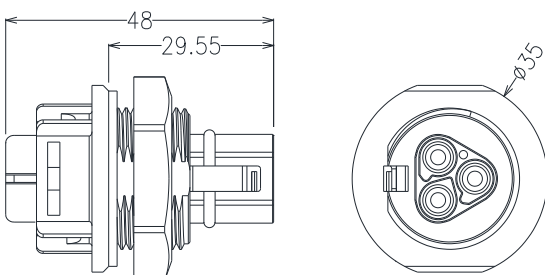

线端公头-线端母头:

Cable male-cable female:

线端母连接器

Female cable end part number:3PCF1-6

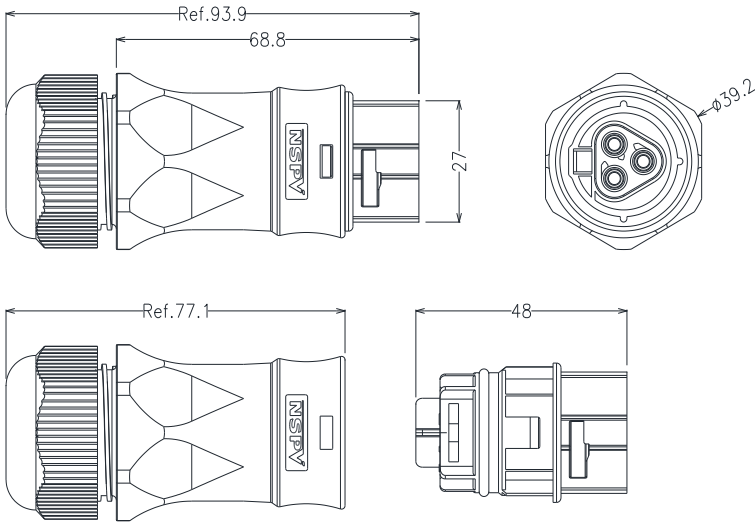

线端公连接器

Male cable connector:3PPM1-6

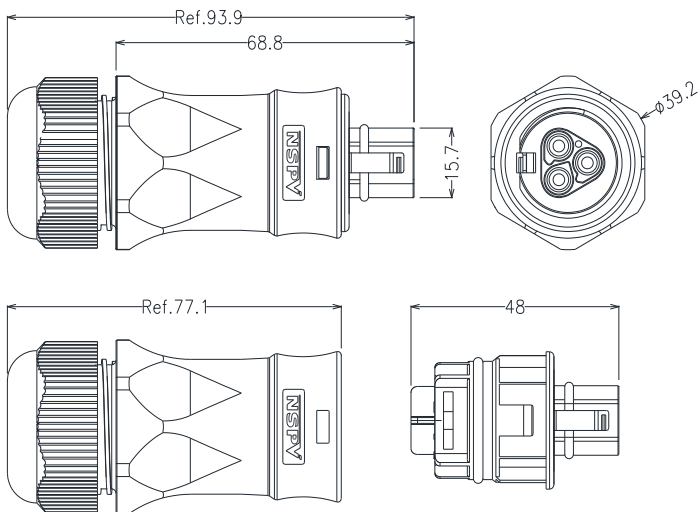

面板孔位尺寸
Panel Hole Size

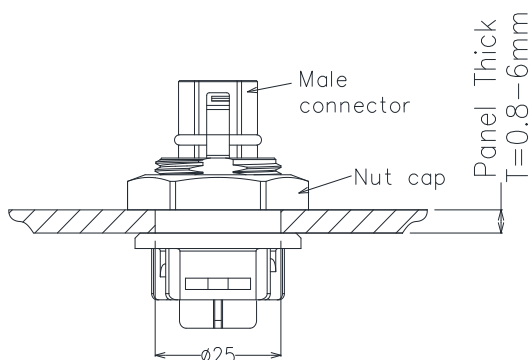

面板尺寸
Panel size

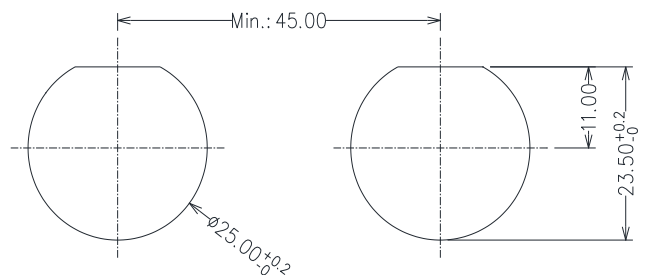

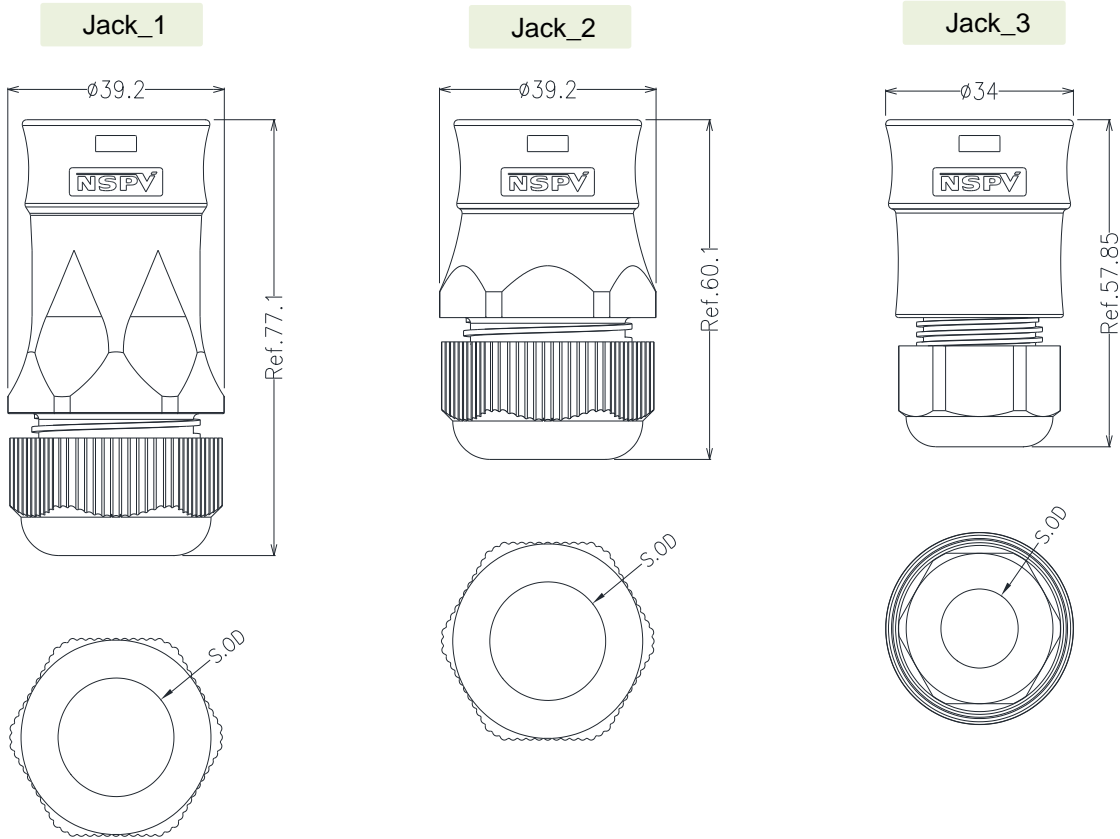
护套和防水圈尺寸(mm)
Housing and seal inner size(mm):

P.N.	S.OD (mm)		
Jack_1	21	18	14
Jack_2	21	18	14
Jack_3	-	-	14

料号 Part number				
Male	Female	No.of pole	Rated current	Wire cross section area
3PPM1	3PCF1	2+PE	Max.15A	1.5mm ²
3PPM2	3PCF2	2+PE	Max.16A	2.5mm ²
3PPM4	3PCF4	2+PE	Max.25A	4.0mm ²
3PPM6	3PCF6	2+PE	Max.35A	6.0mm ²