



DM 01

Battery Powered Precision Digital Gauge

Stainless Steel Sensor

class 0.05

Nominal pressure

from 0 ... 100 mbar up to 0 ... 400 bar

Special characteristics

- ▶ modular sensor concept
- ▶ data logger
- ▶ graphic display
- ▶ stainless steel housing Ø100 mm
- ▶ communication interface USB 2.0

Optional

- ▶ accredited calibration certificate according to DKD / DAkKS
- ▶ IS-version zone 0/1
- ▶ software incl. USB converter
- ▶ service case with accessories

Functions

- ▶ zero point calibration
- ▶ data logger
- ▶ turn off automatic
- ▶ free button assignment
- ▶ background illumination etc.

The digital pressure gauge DM 01 is a precision device fulfilling highest demands. It was conceived especially for the process monitoring and calibration.

The advantage: The DM 01 consists of two devices - the digital display and a pressure transmitter. The pressure transmitter can be selected on site for different measuring ranges and connected to the display - without tools or parameter setting.

Outstanding measuring qualities, an intuitive operation, as well as an innovative, modular sensor concept characterise the DM 01. The battery-powered digital pressure gauge can be used e.g. for controlling pressure courses or calibrating pressure transmitters.

The integrated data logger is able to record pressure and temperature values linearly and cyclically which can be analysed with the software DAQ.

Preferred areas of use are



Calibrating techniques



Laboratory applications



Plant and machine engineering



Input pressure												
Nominal pressure gauge [bar]	-1...0	0.10	0.16	0.25	0.40	0.60	1	1.6	2.5	4	6	
Nominal pressure abs. [bar]	-	-	-	-	0.40	0.60	1	1.6	2.5	4	6	
Overpressure [bar]	5	1	1	1	2	5	5	10	10	17.5	35	
Burst pressure \geq [bar]	7.5	1.5	1.5	1.5	3	7.5	7.5	15	15	25	50	
Nominal pressure gauge / abs. [bar]	10	16	25	40	60	100	160	250	400			
Overpressure [bar]	35	80	80	105	210	600	600	1000	1000			
Burst pressure \geq [bar]	50	120	120	210	420	1000	1000	1250	1250			
Vacuum resistance	$p_N \geq 1$ bar: unlimited vacuum resistant; $p_N < 1$ bar: on request											
Performance												
Accuracy ¹	nominal pressure $p_N \geq 0.4$ bar: $\leq \pm 0.05$ % FSO BFSL nominal pressure $p_N < 0.4$ bar: $\leq \pm 0.125$ % FSO BFSL											
Long term stability	$\leq \pm 0.1$ % FSO / year at reference conditions											
Measuring rate / Display	1, 2 or 50 measurements per second											
¹ accuracy according to IEC 60770 – minimum value setting (non-linearity, hysteresis, repeatability) - at room temperature 20°C												
Thermal effects (offset and span)												
Temperature error	for nominal pressure ranges $p_N \leq 160$ bar: tolerance band $\leq \pm 0.2$ % FSO for nominal pressure ranges $p_N > 160$ bar: tolerance band $\leq \pm 0.75$ % FSO											
compensated range	0 ... 50 °C											
Permissible temperatures												
Permissible temperatures	medium: -10 ... 55 °C storage: -20 ... 70 °C environment: display module: -10 ... 55 °C transmitter: -20 ... 70 °C (at 1G to +60 °C)											
Materials												
Pressure port / housing	stainless steel 1.4404 (316L)											
Display housing	stainless steel 1.4301 (304)											
Seals (media wetted)	FKM, without (welded version) and others on request											
Diaphragm	stainless steel 1.4435 (316L)											
Media wetted parts	pressure port, seal, diaphragm											
Explosion protection												
AX16-DM01	IBExU12ATEX1108 X variant with standard front foil for zone 1: II 2G Ex ia IIB T4 Gb variant with conductive front foil for zone 0: II 1G Ex ia IIC T4 Ga (on request)											
Miscellaneous												
Display	graphic LC display: visible area 55 x 46 mm; (resolution 128x64) figure height 5.5 mm (displaying of pressure value) measured value display: max. 7 digits, depending on pressure range temperature display, time, 100-segment-bargraph, potential input value background illumination: illumination period and intensity adjustable											
Temperature display range	accuracy: ± 2 K resolution: 0.1 K display: -10 ... 55 °C											
Adjustable units pressure and temperature	[mbar], [bar], [psi], [mmHg], [cmHg], [inHg], [kPa], [MPa], [hPa], [mmH ₂ O], [mH ₂ O], [inH ₂ O], [kg/cm ²], [°C], [°F], [K]											
Data logger	modes: single, cyclic, linear, off recording pressure values and sensor temperature measuring value interval adjustable (hrs, min, sec, 20 ms, daily at a defined time) measurement rate adjustable (1/s, 2/s or 50/s only with 20 ms measured value interval) max. 600798 values											
Current consumption	without background illumination: approx. 1.3 mA with background illumination: approx. 16 mA (depending on adjusted intensity) standby mode: approx. 1.2 μ A											
Supply	3x 1.5 V: Duracell Plus battery, DUR087033, AA (LR6)											
Ingress protection	IP 67											
Installation position ²	any											
Weight	approx. 680 g											
A / D-converter resolution	16 bit (module)											
Battery life	standard use: > 2.000 h standby mode: at least 5 years (with measurement rate 1/s and 2/s)											
Operational life	100 million load cycles											
CE-conformity	EMC directive: 2014/30/EU pressure equipment directive: 2014/68/EU (Module A) ³ electromagnetic compatibility: according to EN 6132											
² Pressure transmitters are calibrated in a vertical position with the pressure connection down. If this position is changed on installation there can be slight deviations in the zero point for pressure ranges $p_N \leq 1$ bar.												
³ This directive is only valid for devices with maximum permissible overpressure > 200 bar.												

Dimensions (in mm)

standard

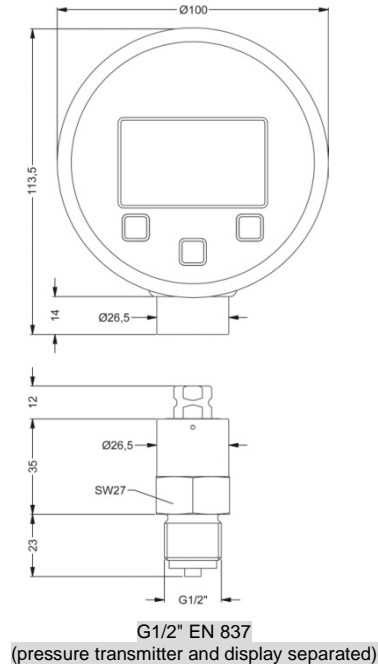
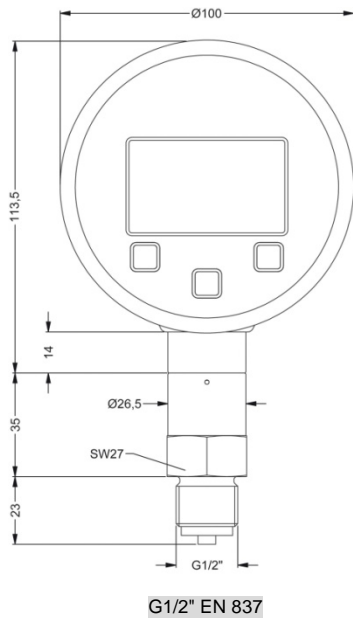

option

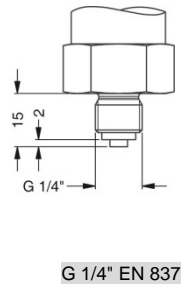
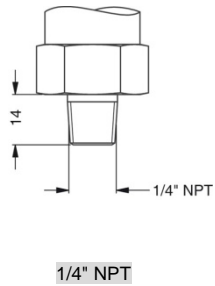
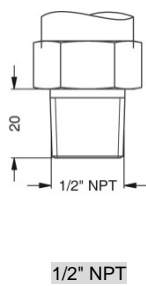
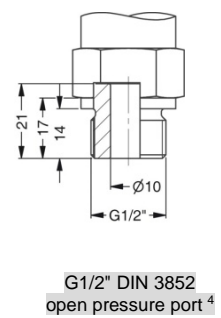
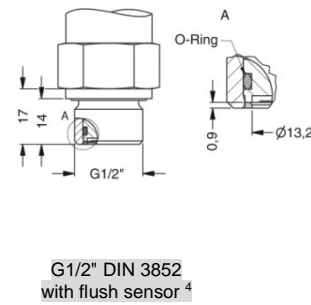
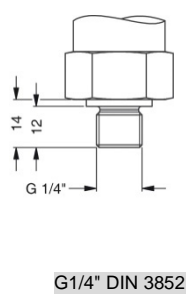
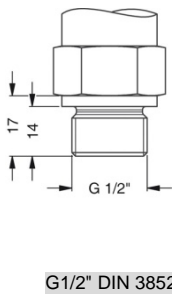

⇒ metrical threads and other variations on request

⁴ only possible for nominal pressure ranges $p_N \leq 40$ bar

Further pressure sensor modules can be combined to the advertisement unity DM01-A21 and DM01-A2E. an overview of available pressure sensor modules and characteristics you will find in the following matrix:

Pressure sensor module						
Name	Pressure range	Filling fluid	diaphragm	accuracy	Special feature	further information
M0	0...0.1 bar up to 0...400 bar	silicone oil	stainless steel 1.4435	0.05% FSO	very high precision	see data sheet
M4	0...6 bar up to 0...600 bar	none; welded version	stainless steel 1.4542	0.25% FSO	i.a. for oxygen; oil and grease free	on request
M7	0...0.1 bar up to 0...10 bar	none	ceramic Al ₂ O ₃ 96%	0.15% FSO	high overpressure	on request

Accessories

Accessories are not in scope of supply and have to be ordered separately!

Software DAQ (Communication, Configuration, Measurement display, Protocol creation)

Optionally software DAQ and an interface cable can be ordered. The software is also available for download on our homepage.

Software:



- display of device information (serial number, pressure and temperature range, ...)
- configuration area for all parameters
- download area for recorded data:
 - date
 - pressure measurement
 - temperature measurement
- protected data acquisition
- measured value representation in tabular or graphic form
- free scaling of the diagram
- creation of measurement / test report as a PDF file
- data export

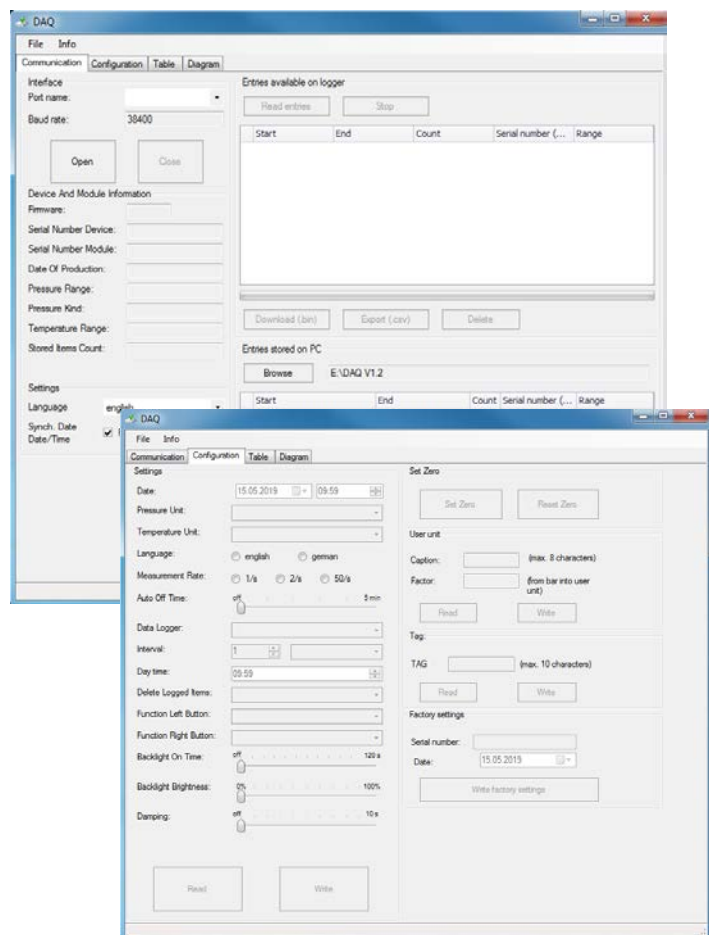

Interface cable USB (type A) to mini connector (3.5 mm) with integrated converter
l: 1.7 m



Ordering number: ZUSBCD01

<p>Hard-shell service case without accessories</p> <p>Service_Case_DM01</p>		<p>Hard shell case.</p> <p>dimension in mm (L x W x H): 432 X 363 X 138</p>
<p>Protective cap</p> <p>Ordering number: Z1002648</p>		<p>Rubber protection</p>
<p>Additional batteries</p> <p>(only in combination with service case)</p>		<p>for IS-version use only 3 x 1.5 V / AA Duracell Power Plus</p>
<p>Seal set</p> <p>(only in combination with service case)</p>		<p>Flat seal copper for mechanical connections according to EN 837</p>
<p>PTFE seal tape Nr. 498.505</p> <p>(only in combination with service case)</p>		<p>Seal tape for mechanical connections</p> <p>material: PTFE (Teflon) temperature range: -200 ... 280 °C</p>
<p>Wrench</p> <p>(only in combination with service case)</p>		<p>Wrench SW 27</p>
<p>Calibration test pump KHP 4002 including pressure test tube</p> <p>Reference connection: G1/2" EN 837</p> <p>Test unit connection: G1/4" EN 837</p> <p>Ordering number: 1002637</p>		<p>The calibration test pump is used to generate pressure and vacuum for checking, adjusting and calibrating mechanical and electronic pressure measuring instruments by comparative measurements.</p> <p>These pressure tests may be carried out in laboratories, workshop or on site at the measuring point.</p> <p>pressure: 0 ... 40 bar vacuum: 0 ... -0.95 bar weight: approx. 510 g dimension: approx. 220 x 105 x 63 mm</p>

© 2023 BD|SENSORS GmbH – The specifications given in this document represent the state of engineering at the time of publishing. We reserve the right to make modifications to the specifications and materials.

