

Type NORIMETER 3 analogue indicator

360° indicator with stepper motor technology

universally applicable



Construction type	Square type NIQ31
Display principle	Stepper motor principle
Housing sizes	Square: 72 x 72 mm, 96 x 96 mm, 144 x 144 mm
Protection class	DIN EN 60529: Front of housing IP66, IP67 and IP68 (1 m, 24 h); rear of housing IP30 (standard, higher on request)
Measured variables	Analogue measurement signals (current/ voltage); frequency signals, resistive sensor signals (Pt100/Pt1000, NTC thermistor, resistance)
Scale angular	Instrument faceplate 360°
Class of accuracy	IEC 60051-1: 0.5
Housing material	Glas fibre reinforced and uv stabilised plas- tic; upper part: PC GF10; base plate: PC GF30; face made of lumenized float glass
Illumination	Externally dimmable LED illumination
Supply voltage	18 ... 36 VDC, other voltages on request
Fire protection	DIN EN 45545; UL94: V0 (all housing parts)



Analogue Indicator NIQ31



Scope of application

Type NIQ31 analogue indicators are commonly used in the fields of the Shipbuilding industry, e.g, to indicate the rudder position, propeller position and pitch on ships. Signals commonly used in industry, such as analogue measuring signals, are fed in directly and shown on a customised scale with a dial that can be turned through 360°. Thanks to its mechanical design, the casing is extremely resistant to salt spray, enabling use in outdoor applications. The DIN-compliant housing sizes are suitable for installation in control cabinets and control panels with pre-stamped standardised installation openings.

Display principle

A high resolution motor without a mechanical stop is used in 360° indicators to enable continuous rotation of the dial. The entire measuring range is divided into 4320 graduations. As the motor in this indicator has no mechanical stop, the zero point is found by scanning of a position marker on the underside of the dial.

Gear backlash of the stepper motor is virtually eliminated by a special motor controller. This method enables pinpoint positioning accuracy of the dial in both directions. The indicator additionally corrects the gear backlash every second when the dial is stationary. The reading is corrected if it deviates from the correct value (within the gear backlash) due to impact or vibration.

Special features

- Long lifetime due to compact and robust technology, a high protection class and a glass-fibre-reinforced, salt spray resistant plastic housing, suitable for outdoor areas
- Individual scale design and corporate logos possible, even for small quantities
- Monitoring for valid measuring signal
- Option: Minimum-Maximum value indication for saving and indicating the highest and lowest measured value
- Fulfils all conventional ship classifications
- Option: Motor with anti-clockwise rotation

Indicator versions

The following illustration show the available indicator sizes

Indicator sizes - Type NIQ31, 360° indicator



From left to right: Type NIQ31 72x72 mm, 96x96 mm, 144x144 mm

Standard version

Scale and dial

The scale is marked and graduated according to customer requirements.

Scale and dial (black)		
	Standard version	Customised versions
Graduations and dial markings	Left red, right green	Available in all RAL colours in accordance with customer requirements, own logos possible
Type of graduation	Orientation graduation or any other scale graduations available according to customer requirements	
Illumination	White	
Scale illumination and dial illumination effects	---	Without illumination: white graduations and scale markings; with illumination: graduations and scale markings red, green or in any other translucent colour
Dial	Black with white symbol (translucent)	Black with customised symbol in any colour (translucent)

Note:

The scale and dial are also possible in white or any other RAL colour but without illumination.

Example of scales, standard and customised versions

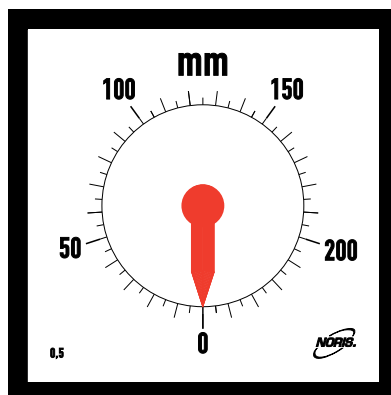
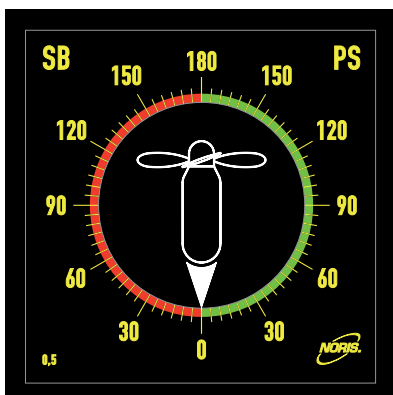
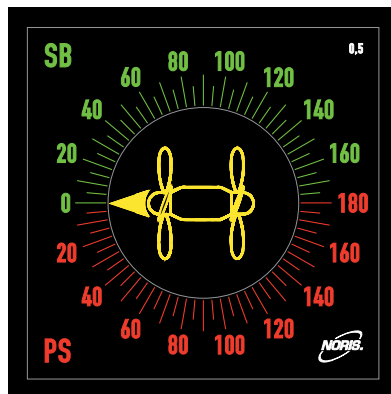
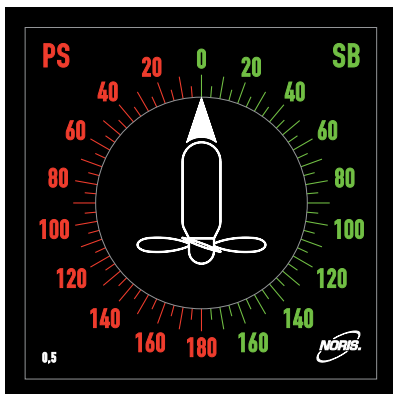

Zero point, return point and scale measuring range

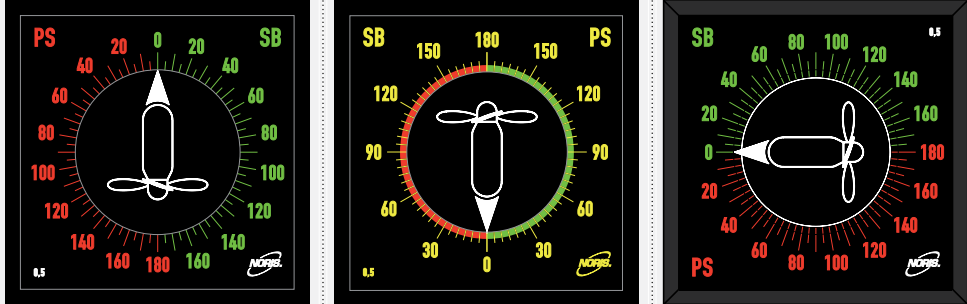
Possible versions	
Scale zero point	<p>The position of the scale zero point can be specified as required.</p> <p>Standard: Scale zero point in 12 o'clock position</p> <p>Option: Scale zero point in 6 o'clock position</p> <p>Option: Scale zero point in any position</p> 
Start of signal with positioning optimisation (*)	<ul style="list-style-type: none"> • Standard: Start of signal at scale zero point • Option: Start of signal in any other position, e.g. 8 o'clock position
Without positioning optimisation (*)	<ul style="list-style-type: none"> • 360° indicators without positioning optimisation(*) (with dial return) are available as special types, e.g. for measuring temperature, pressure, frequency, etc. (scale angle ≤ 360°)
Return point	<ul style="list-style-type: none"> • The dial moves to the return point when operating voltage is no longer applied • The return point does not need to be the scale zero point • Standard: Return point at scale zero point • Option: Return point in any other position
Measuring range	<ul style="list-style-type: none"> • Standard: Indicator with linear measuring range, right side 0...175° (green), left side 180...5° (red) • Option: Indicator with non-linear measuring range (scale spread)
Scale angle	<ul style="list-style-type: none"> • Standard: 360° • Option: Any scale angle < 360°

(*) Positioning optimisation

The dial in indicators with positioning optimisation can turn in a circle. The dial in indicators without positioning optimisation only turns between the minimum and maximum signal.

Illumination

A common, controlled LED illumination system illuminates the scale and dial. The scale and dial are lit brightly and uniformly from the rear by a light panel (transmitted illumination principle). The power dissipation and thus the intrinsic heat build-up of the indicator are very low. The illuminance can be set between 0 and 100% in 1% steps.

Two ways to control the brightness:

Setting the default brightness	<ul style="list-style-type: none"> • Setting between 30% and 100% using the two buttons (up/down) on the rear of the indicator housing (allows it to be adapted to suit the default brightness setting of other equipment in the surrounding area) • The factory default for illumination brightness is 100 %. • This setting influences both the scale and dial illumination. • The change in brightness is saved in the internal flash memory (even after switching off the supply voltage).
Illumination control via a control signal on the connector	<ul style="list-style-type: none"> • Control of the illumination between zero and the preset default brightness • Controllable via commercially available 24V dimmer or a DC or AC voltage with any polarity (0...24 V)

Monitoring functions

Integrated measuring signal monitoring detects:

- Total sensor failure / invalid sensor signals
- Broken wire in the sensor cable
- Short circuit in the sensor cable

The error is shown by:

- The light at maximum brightness slowly flashing

There are further possible monitoring functions for 360° indicators without positioning optimisation (depending on the measured variable):

Indicator type and measured variable	Monitored operating conditions
U1, U4, U0 (without Live Zero), I1, I4, I0 (without Live Zero), F1, F2, FD1, FD2	Measuring signal exceeded
U2, I2, U0 and I0 with Live Zero	Measuring signal exceeded or not reached, short circuit and broken signal line
PT100 / PT1000, NTC thermistor	Measuring signal exceeded or not reached, short circuit and broken signal line
RO	Measuring signal exceeded, broken signal line

Changing the direction of rotation

With this function, you can manually change the direction of rotation of the dial with the push button on the rear side of the indicator (clockwise or anti-clockwise). This can be useful e. g. for mirrored indication (Bridge or Astern Bridge).

Zero-point adjustment

The zero-point of the indicator can be adjusted manually with the push buttons on the rear side of the indicator. This can be useful, e. g. if the rotary position sensor was not attuned to the position of the engine nacelle. A new zero-point can be only adjusted in the preset direction of rotation within the Min- Max limits of the origin zero-point. Note that the class of accuracy IEC 60051-1: 0.5 can be only guaranteed with the original factory setting.

Line compensation for indicators with resistive signal inputs

NOTICE	<p>ATTENTION: Line compensation changes the factory setting. Incorrect line compensation can cause the reading to deviate from the actual measured values.</p> <p>It may then not be possible to detect when limit values are overshoot or undershot. NORIS shall accept no liability for any damage which may be incurred as the result of incorrect line compensation.</p>
---------------	---

For indicators with PT100/PT1000-, NTC thermistor or resistance inputs, the optional function "Line Compensation" is implemented as standard. Thus, the indication can be adapted to probable existing signal line resistances. For further information please read Section "Optional special functions".

Optional special functions

Functional overview

Overview of auxiliary functions	Availability
Minimum/maximum display (AUX)	All types except FD1, FD2, PT100/PT1000 3- and 4-wire
Limit value switch (AUX)	U1, U2, U4, I1, I2 and I4
Line compensation	Possible for all types; standard in PT100, PT1000, NTC thermistor and resistance types
Motor with anti-clockwise rotation	All types

Min/max display

Indicators with this optional auxiliary function register fluctuations of the measuring signal and save the highest and the lowest measured value in the internal measured-value memory. Critical measured values that, for example, occur during the absence of monitoring personnel can therefore be recalled later on. By means of a signal at the indicator's auxiliary port (e.g. via an external button), the saved values can be displayed or deleted.

Note: The min/max data is not permanently saved and is lost when the indicator is switched off.

Limit value switch output

Note: The functional principle of the relay contact and the subsequent assignment of the switching point must be stated in the order and can then no longer be changed by the customer.

Indicators with this auxiliary function have an additional relay card with switching output, with which an external device (e.g. a signal beeper or signalling device, etc.) can be switched.

The switching point of the limit value switch can be selected as follows:

- Coupling of the switching point to a defined measured value, e.g. excessive speed or overtemperature, etc.
- Change to the switching status in one or several measuring ranges, e.g. signal in the red measuring range or signal out of the green measuring range

For further information refer to the specifications for the relay contact in the technical data.

Line compensation

With this optional auxiliary function, two different types of line compensation can be carried out using the buttons on the rear.

1. Proportional line compensation

With proportional line compensation, the value shown on the display can be changed by up to $\pm 10\%$. When measuring voltages for example, this allows a potential voltage drop over the supply lines and the connection terminals to be compensated for.

2. Linear line compensation

With linear line compensation, the display can be changed by up to $\pm 5\%$ of the full-scale value. When using resistive sensors (PT100 / PT1000, NTC thermistors or resistance type) for example, this allows the line resistance to be compensated for.

Basically, the "line compensation" function allows the displayed value to be adjusted to match the actual or desired measured value under difficult conditions.

Caution: Line compensation changes the default compensation of the indicator, meaning that the indicator no longer shows the original exact value. The default setting can, however, be reset.

Note: On indicators with PT100, PT1000, NTC thermistor or resistance input, line compensation is integrated in functional scope.

Motor with anti-clockwise rotation

The dial in indicators that turn in anti-clockwise direction turns anticlockwise with increasing signal level. This function is used for special applications such as mirrored indication.

Measured quantities

The following measured quantities with the specified signal measurement ranges can be connected directly to type NORIMETER 3 indicators without using additional measuring transducers. Other measured quantities are available on request with additional measuring transducers.

DC voltage

Indicator type	Measurement range
-U1	0...10 V
-U2	2...10 V
-U4	-10 V ...0... +10 V
-U0	Special calibration: freely selectable within the specified range limits below. <ul style="list-style-type: none"> • Minimum range limit: 0 ... 600 mV or -300 mV ...0... +300 mV • Maximum range limit: 0...300 V or -150 V ...0... +150 V For further information please read the technical data.

DC current

Indicator type	Measurement range
-I1	0 ... 20 mA
-I2	4 ... 20 mA
-I4	-20 mA ...0... +20 mA
-I0	Special calibration: freely selectable within the specified range limits below. <ul style="list-style-type: none"> • Minimum range limit: 0 ... 20 μA or -10 μA ...0... +10 μA • Maximum range limit: 0...500 mA or -250 mA ...0... +250 mA For further information please read the technical data.

Frequency

Indicator type	Measurement range
-F1	For square wave signals or other pulsating DC voltages, for AC voltages $\geq 20V_{pp}$, e. g. for sensors with measuring amplifier and tachogenerators
-F2	For AC voltages, e. g. for inductive sensors without measuring amplifier (Note: From an amplitude of $\geq 20V_{pp}$ or higher, the type „-F1“ should be used for AC voltages, too)
-FD1	For square wave signals or other pulsating DC voltages with second measuring channel for direction of rotation detection, e. g. for sensors with measuring amplifier, but not suitable for tachogenerators
-FD2	For AC voltages with second measuring channel for direction of rotation detection, e. g. for inductive sensors without measuring amplifier and tachogenerators
Measurement range: 0.2 Hz to 140 kHz; Scale end value: ≥ 10 Hz to 140 kHz; frequencies under 0.2 Hz will be show as 0 Hz	
Signal form: all signal forms	
Signal level: Type -F1 or -FD1 (pulsating DC voltage and AC voltages $\geq 20 V_{pp}$): Low level ≤ 4 V, High level $\geq 6,5$ V. Type -F2 or -FD2 (AC voltage): $200 mV_{pp}$ to $400 V_{pp}$. Other signal levels available on request. Please also note the information in the technical data!	

Temperature Pt100/Pt1000

Indicator type	Type	Signal measurement range
-Px / -PTx	Pt100 / Pt1000 with two-wire-connection	x=1 [0 ... 120 °C] x=12 [0 ... 100 °C]
PxL3 / PTxL3	Pt100 / Pt1000 with three-wire-connection	x=11 [-30...120 °C] x=2 [0 ... 150 °C] x=3 [0 ... 200 °C]
PxL4 / PTxL4	Pt100 / Pt1000 with four-wire-connection	x=4 [0 ... 250 °C] x=5 [0 ... 300 °C] x=6 [0 ... 400 °C] x=7 [0 ... 500 °C] x=8 [0 ... 600 °C] x=0 [Special calibration freely selectable within the specified range limits]: Start limit: -30 °C ... 0 °C End limit: 50 °C ... 600 °C Example: PT0, measurement range: -10 °C... 220 °C or -5 °C ... 180 °C

Temperature NTC Thermistor

Indicator type	Signal measurement range
-H1	40 ... 120 °C
-H2	5 ... 70 °C
-H3	114 ... 200 °C
-H0	Special calibration: Other signal measurement ranges available on request

Resistance

Indicator type	Signal measurement range
-R0	Indicators with resistance measuring input are suitable for resistive sensors (e. g. pressure sensors, level meter, etc.) in two-wire connection. The signal measurement range is freely selectable between 0...10 Ω and 0...500 Ω.

Dimensioned drawing, connection and wiring diagrams

Dimensions of square version NIQ31

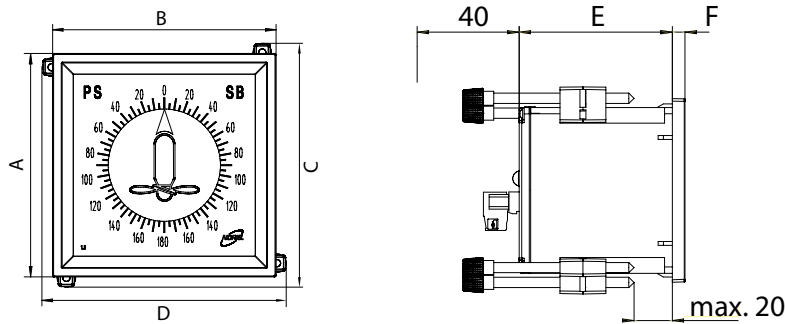

Indicator type	A	B	C	D	E	F	Control panel cut-out	Permissible deviation
NIQ31-072...	72	72	81	81	60	5	67.5 x 67.5	+0.5
NIQ31-096...	96	96	105	105	60	5	91.5 x 91.5	+0.8
NIQ31-144...	144	144	153	153	61	8	137.5 x 137.5	+1.0

All dimensions in mm

Connector and pin assignments

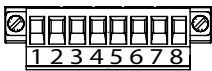

1: 8x3 connector

Pin	Indicator labeling	Description
1	U _s +	Supply voltage +
2	U _s - (0 V)	Supply voltage - (0V)
3	Illum. + (<24V)	Illumination control input, positive (24 VDC)
4	Illum. -	Illumination control input, negative
5	Signal LED / N.C. / Q2 (type-specific)	Auxiliary positive connection
6	24 VDC / N.C. (type-specific)	Auxiliary negative connection
7	Meas. Sign. + (type-specific)	Measuring signal input, positive
8	Meas. Sign. - (type-specific)	Measuring signal input, negative

Terminal diagram

Free pins in the diagrams below are not connected for the respective signal type.

Type -F1

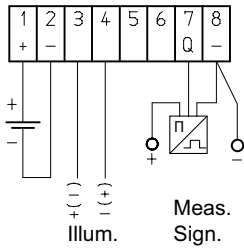

Type -F2

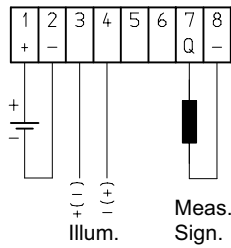

Type -FD1

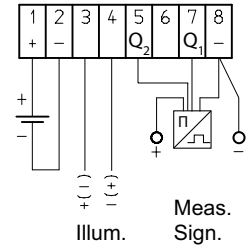

Type -FD2

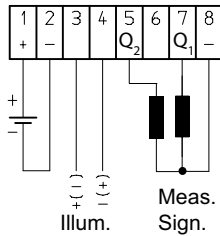

**Type -I1, -I2, -I0
Type -U1, -U2, -U0**

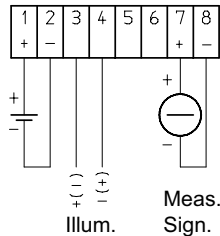

Type -I4, -U4, -UG0,

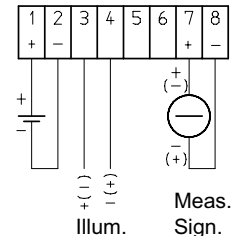

**Type -H1, -H2, -H3,
-R0 see * in Fig.**

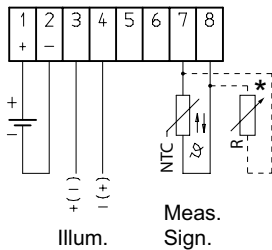

Type -Px, -PTx (2-wire)

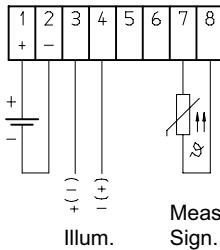

Type PxL3, Type PTxL3 (3-wire)

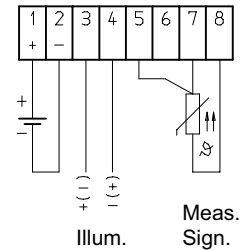

Type -PxL4, -PTxL4 (4-wire)

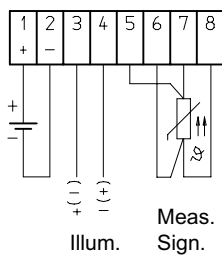

**Connection of relay output
or 24 VDC control input**

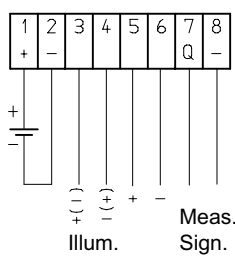

**Connection of
Auxiliary push button**

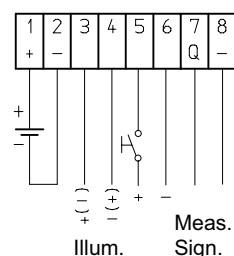

Technical data

Electrical connection	
Supply voltage	18 ... 36 VDC, other voltages on request
Nominal voltage	24 VDC
Power consumption	2 W maximum
Reverse voltage protection	Yes
Over voltage protection	Yes
Connection	8-pin connector
Galvanic isolation	4 galvanically isolated inputs and outputs
Input signal	
Analogue measurement signals	0...10 VDC (Ri = 29 kΩ); 2...10 VDC; (Ri = 29 kΩ); -10...+10 VDC (Ri = 26 kΩ); 0...20 mA DC (Ri = 121 Ω); 4 ... 20 mA (Ri = 121 Ω); -20 ... +20 mA (Ri = 59 Ω); customer-specific measuring ranges on request
Frequency signals	Frequency range: 0.2Hz...140kHz; full-scale value ≥ 10 Hz...140 kHz; < 0.2 Hz is shown as 0 Hz Signal shape: all signal shapes Pulsating direct voltage: Low level ≤ 4 V; high level ≥ 6.5 V, max. 200 Vp Internal resistance Ri: > 220 kΩ for all signals, 10 kΩ termination available Sensor type options: Sensors with measuring amplifier and with "open collector" as NPN or PNP output or with push-pull output stage; inductive sensors without measuring amplifier; tachogenerators: with alternating voltage output Note: For "open collector" PNP or NPN sensors without internal pull-up or pull-down resistors, a corresponding 10 kΩ resistor can be switched in the NORIMETER 3 on request.
Resistive sensor signals	Pt100/Pt1000 in 2-, 3- and 4-wire technology; -30 °C ... 600 °C; measuring current Pt100 = 1.6 mA, Pt1000 = 0.17 mA NTC thermistor; H1: 40...120 °C; H2: 5...70 °C; H3: 114...200 °C Resistance, customer-specific compensation
Input for illumination control	Commercially available 24 V PWM dimmers (positive or negative regulator) or 0...24 V DC or AC voltage (either polarity); Ri = approx. 17 kΩ
Auxiliary input (binary input)	Binary connection, for external control of alarm LED or blinking pointer ; ≤5V = Off (Low); ≥9 V up to max. 36 V = On (High)
Auxiliary input (direction-of-rotation monitoring, multi-wire)	Pin 5: Q2 input for direction of rotation signal for frequency indicators with direction of rotation indication (input for wire 3 for PT100 / PT1000 in three-wire or 4-wire technology; Pin 6: input for wire 4 for PT100 / PT1000 in four-wire technology
Auxiliary output (relay output)	Magnetic contact relay, switching contact as normally closed or normally open as operating or closed-circuit current Maximaler Schaltspannung: 110 VDC oder 125 VAC Maximum switch current: 1 A at ≤ 30 VDC; 0.5 A at ≤ 125 VAC (at resistive load) Maximum switch capacity: 30 WDC or 62.5 WAC (at resistive load) Maximum contact resistance: 50 mΩ
Class of accuracy	IEC 60051-1: 0.5
Measurement signal resolution	10 bit
Stepper motor resolution	12 motor steps per angular degree

Environmental influences	
Operating temperature	Reference range of operation: -25 ... +70 °C, nominal range of operation: -25 ... +70 °C
Storage temperature	-40 ... +70 °C (max. peak values within 30 day/year at relative humidity of 5...95%)
Protection class	DIN EN 60529: Front of housing IP66, IP67 and IP68 (1 m, 24 h); rear of housing IP30 (standard, higher on request)
Salt spray resistance	IEC 60068-2-52: Test severity class 1 (open deck) and test severity class 4 (de-icing salt)
Vibration resistance	DIN IEC 60068-T2-6: 4 g, test duration 3 x 90 minutes (at 100 Hz)
Shock resistance	DIN EN 61373: 5 g at 30 ms; 10 g at 18 ms
Climatic test	IEC 60068-2-1: dry coldness -25 °C, test duration 16 h IEC 60068-2-2: dry heat 70 °C, test duration 16 h IEC 60068-2-30 damp heat ≤ 95% relative at 55 °C, test duration 2 x 12 h
ESD	IEC 61000-4-2 and EN 50121-3-2, Tab. 9.3, evaluation criterion "A": Air discharge 8 kV; contact discharge 6 kV
Burst	IEC 61000-4-4 and EN 50121-3-2 table 7.2 and table 8.2: 2 kV for supply connection, signal connection, data connection and control connection
Surge	IEC 61000-4-5, EN 50121-3-2, Tab. 7.3: US+ to US- with 1.0 kV, Ri = 2 Ω
RF interference immunity	IEC 61000-4-3: 80 MHz...2 GHz, 80% AM with 1 KHz, E = 10 Veff/m EN 50121-3-2, Tab. 9.1 und 9.2 80 MHz...1 GHz, 80% AM with 1 KHz, E = 20 Veff/m 1.4 GHz...2.1 GHz, 80% AM with 1 KHz, E = 10 Veff/m 2.1 GHz...2.5 GHz, 80% AM with 1 KHz, E = 5 Veff/m
Conducted RF interference	IEC61000-4-6 and EN50121-3-2, Tab. 7.1 and 8.1: f = 150 kHz ... 80 MHz at 80 % AM @ 1 kHz, V = 10 Veff
Conducted AF interference	GL2012 GL2003: 50 Hz...10 kHz, V = 3 Veff
Emitted interference	CISPR 16-1, CISPR 16-2 EMC2 EN50121-3-2, Tab. 4: Battery-related connections 150 KHz...30 MHz EN50121-3-2, Tab. 6: Housing 30 MHz...1 GHz
Insulation voltage	1000 VDC between all electrical inputs and outputs

Mechanical properties	
Housing material	Glas fibre reinforced and uv stabilised plastic; upper part: PC GF10; base plate: PC GF30; face made of lumenized float glass
Installation position	Any
Weight	NIQ31-072: 170 g
Housing sizes	NIQ31-096: 250 g
Motor torque	NIQ31-144: 510 g

Other	
Illumination	Externally dimmable LED illumination
Initialising time	Approx. 5 s after switching on the supply voltage
Minimum switch on period	2 minutes to permanently save a changed default brightness setting; 3 minutes so that the indicator disc returns to the zero point from any position
Scale angular	Instrument faceplate 360°
Fire protection	DIN EN 45545; UL94: V0 (all housing parts)
Approvals	CE, ABS, BV, DNV-GL, LR, MED
Further standards	DIN EN 50155 (railway application)

Type code

Ordering information

- Not all variants of the NORIMETER 3 indicator can be derived from the type code.
- For the indicator types: F1, FD1, F2, FD2, H0, I0, P0, PT0, U0, UG0 and R0 the signal measuring range required must be specified in addition to the type code.
- All optional auxiliary functions [▶ 6] required must also be specified in the order text.
- Indicators will be delivered with positioning optimisation (standard) if positioning optimisation [▶ 4] requirements are not specified.
- To ensure the dial design is implemented as accurately as possible, exact descriptions, drawings or photos should accompany the order.
- The scale design number and V number (see type code) are allocated by NORIS.
- Please note that indicators with 240° scale and pointer are described in a separate data sheet (see DB-NIR3_NIQ3).

Type code structure								
NI	Q	31	-072	-F1	-123	-MED	Example NIQ31-072-U1-1234-MED	
		Housing type						
		Series						
		Housing size						
			Input signal					
				Scale version				
					Approval			

Type code				
NI	Indicator from the NORIMETER product family			
Housing type	Q	Square		
Series	31	Scale angle of up to 360° with dial		
Housing size	-072	Square 72 x 72 mm		
	-096	Square 96 x 96 mm		
	-144	Square 144 x 144 mm		
Input signal	-F1	Frequency, pulsating DC voltage, 0.2 Hz...140 kHz		
	-F2	Frequency, AC voltage, 0.2 Hz...140 kHz		
	-FD1	Frequency, pulsating DC voltage with integrated direction-of-rotation monitoring		
	-FD2	Frequency, pulsating AC voltage with integrated direction-of-rotation monitoring		
	-H1	NTC thermistor 40...120 °C		
	-H2	NTC thermistor 5...70 °C		
	-H3	NTC thermistor 114...200 °C		
	-H0	NTC thermistor, customer-specific compensation		
	-I1	Direct current 0...20 mA		
	-I2	Direct current 4...20 mA		
	-I4	Direct current -20...0...+20 mA		
	-I0	Direct current, customer-specific compensation		
	-Px	Pt100; 2-wire (x = measuring range, see next Item x)		
	-PxL3	Pt100; 3-wire (x = measuring range, see next Item x)		
	-PxL4	Pt100; 4-wire (x = measuring range, see next Item x)		
	-PTx	Pt1000; 2-wire (x = measuring range, see next Item x)		
	-PTxL3	Pt1000; 3-wire (x = measuring range, see next Item x)		
	-PTxL4	Pt1000; 4-wire (x = measuring range, see next Item x)		
	x	1	0 ... 120 °C	2 0 ... 150 °C
		3	0 ... 200 °C	4 0 ... 250 °C
		5	0 ... 300 °C	6 0 ... 400 °C
		7	0 ... 500 °C	8 0 ... 600 °C
		11	-30 ... 120 °C	12 0 ... 100 °C
		0	Customer-specific compensation	
		R0	Resistance, customer-specific compensation	
		-U1	DC voltage, 0 – 10 VDC	
		-U2	DC voltage, 2 – 10 VDC	
		-U4	DC voltage, -10...0...+10 VDC	
		-U0	DC voltage, customer-specific compensation	
		-UG0	DC voltage, customer-specific compensation for GE1214 tachometer	
	Scale version	-1234	Measuring range, graduation	
	Customer-specific pointer	V567	Customer-specific pointer	
Approval	-MED	GL MED approval for shipbuilding		
NI	-	-	Example: NIQ31-072-U1-1234-MED	

Scale design

Note: Please note that the design code for the scale layout is not a part number and is also not included in the type code. It serves as supplementary information and an ordering aid and must be additionally specified together with the required type according to the type code.

Design code for scale layout											
Graduation	0	Standard: Orientation graduation									
	1	Customised									
Scale arc	0	Standard: No arc, only scale graduations and markings									
	1	Wide									
	2	Narrow									
Motor type	0	Standard: 360° / clockwise rotating									
	1	360° / anti-clockwise rotating									
Symbol on dial	0	Standard: Propeller 1									
	1	Propeller 2									
	2	Propeller 3									
	3	Propeller 4									
	4	Pointer 1									
	5	Pointer 2									
	X	Other symbol									
Dial colour variants	1	Standard: White symbol, white illumination									
	2	Red symbol, red illumination									
	3	White symbol, red illumination									
	4	Yellow symbol, yellow illumination									
	5	White symbol, yellow illumination									
	Scale graduation	0	Standard: Red/green graduation, red/green illumination								
1		Green/red graduation, green/red illumination									
2		Red graduation, red illumination									
3		Yellow graduation, yellow illumination									
4		Green graduation, green illumination									
5		White graduation, white illumination									
Scale markings	0	Standard: Red (left)/green (right) markings, red/green illumination									
	1	White markings, white illumination									
	2	Green (left)/red (right) markings, green/red illumination									
Scale zero point	0	Standard: Zero point in 12 o'clock position									
	1	Zero point in 6 o'clock position									
	X	Zero point in other position									
	Return point	0	Standard: Return point at scale zero point								
1		Return point in 8 o'clock position									
X		Return point in other position									
Design code		0	0	0	1	2	0	0	2	2	1

Symbol on dial

Propeller 1 (standard)

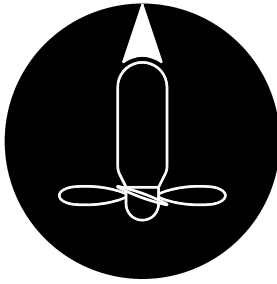

Propeller 2

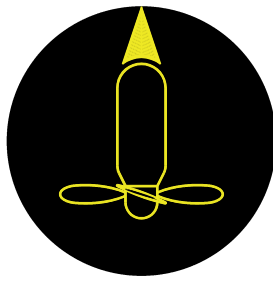

Propeller 3

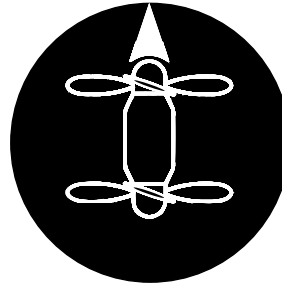

Propeller 4

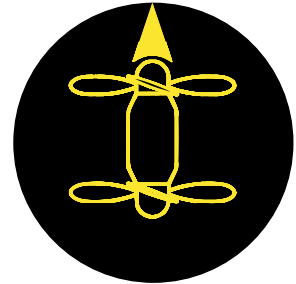

Pointer 1

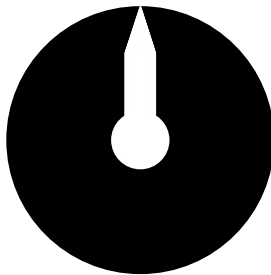

Pointer 2

