

**Name: The pallet**

**Type: 20-318**

**Technical parameters**

Load capacity	5000 kg
Length of pallet	2500-3600 mm
Width of pallet	800 – 1400 mm
Height of pallet	1000-2500 mm
Weight of pallet	455-680 kg
Pulling or pushing force	60 kN
Speed of travelling	2 m/s
Rail profile	I 155, I 140E, I 140V
Maximum inclination of the route	27°

**Figure**

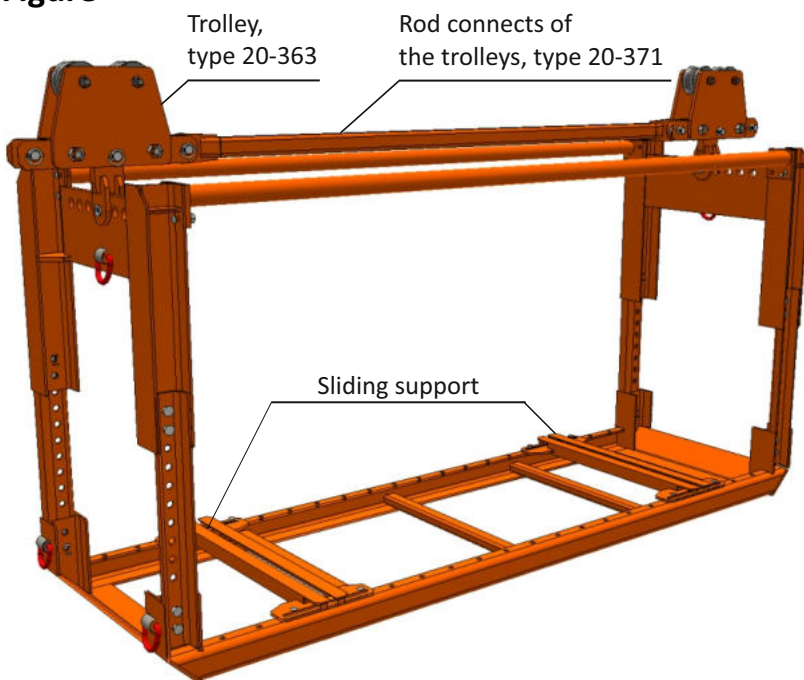

The pallet type 20-318, suspended onto trolleys, type 20-363

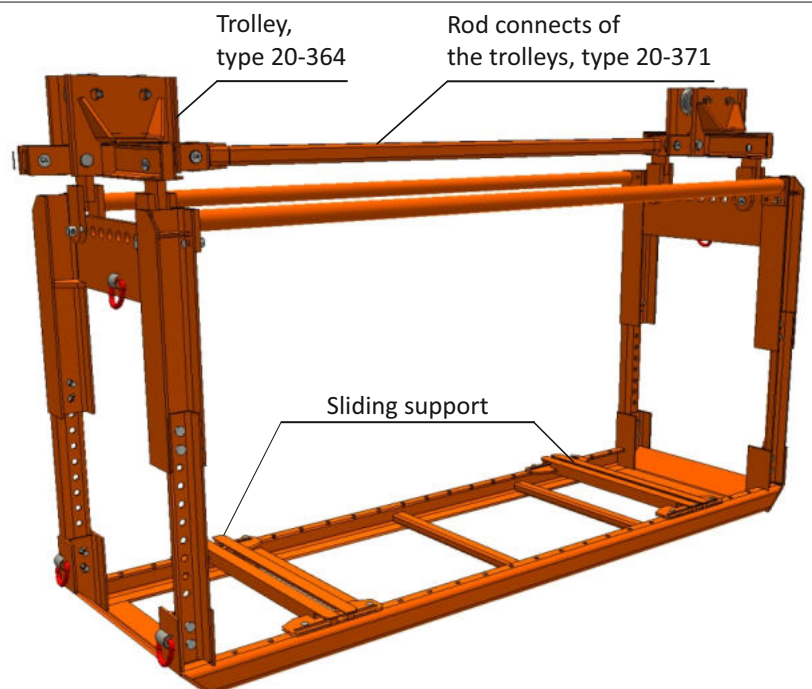

The pallet type 20-318, suspended onto trolleys, type 20-364

**Name: The pallet**

**Type: 20-318**

The pallet type 20-318 with a compact station

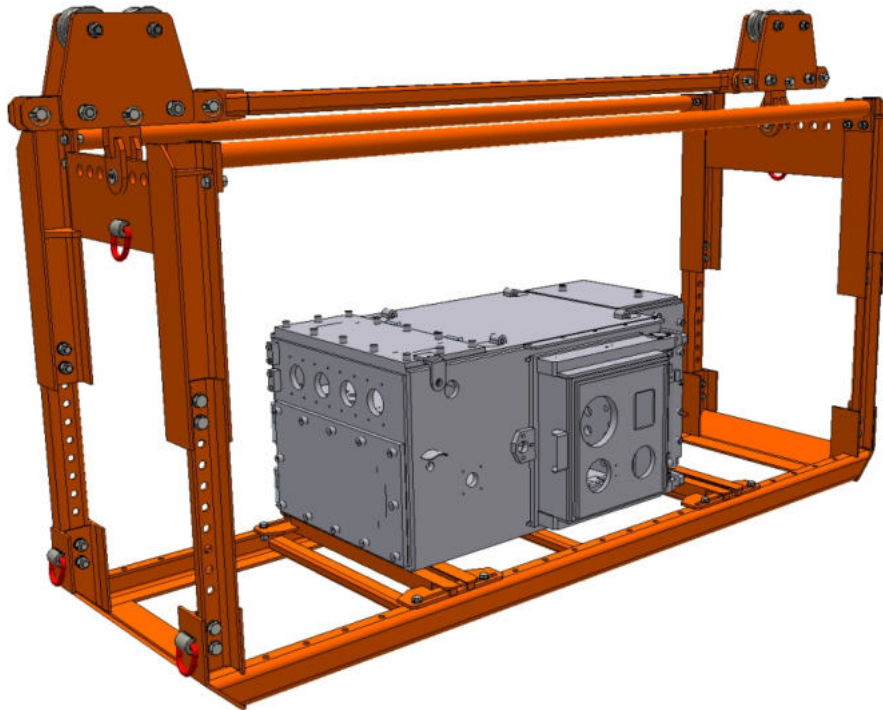

## Purpose

The pallet type 20-318 is used to transport various types of electrical equipment, as well as other machines and equipment, along the tracks of a suspended monorail transport system, installed in underground mines, in methane and non-methane areas, in excavations of the A, B and C class of methane explosion hazard, as well as the A and B class of coal dust explosion hazard.

The pallet is intended for the installation in the transport unit of a train with electric system, driven by a self-locking sliding device of 20-101 type. The pallet can also be joined directly or coupled with a transport unit and a diesel locomotive, switching car and other types of drive, approved for application in underground mines.

## Additional information

Declaration, concerning the meeting of the technical requirements, by the product.