



DS 202

Electronic Pressure Switch

Welded, Dry Stainless Steel Sensor

accuracy according to IEC 60770:
0.5 % FSO

Nominal pressure

from 0 ... 16 bar up to 0 ... 600 bar

Contacts

1, 2 or 4 independent PNP contacts,
freely configurable

Analogue output

2-wire: 4 ... 20 mA
3-wire: 4 ... 20 mA / 0 ... 10 V
others on request

Special characteristics

- ▶ indication of measured values
on a 4-digit LED display
- ▶ rotatable and configurable
display module

Optional versions

- ▶ **IS-version**
Ex ia = intrinsically safe for gases
- ▶ oxygen application
- ▶ customer specific versions





The electronic pressure switch DS 202 is the successful combination of

- ▶ robust pressure transmitter
- ▶ digital display

and has been specially designed for numerous applications in various industrial sectors.

As standard the DS 202 offers a PNP contact and a rotatable display module with 4-digit LED display. The transmitters are suitable for an unrestricted use in oxygen applications up to 600 bar and an intrinsically safe IS-Version.

Preferred areas of use are

-  Medical technology
-  Plant and machine engineering
-  Refrigeration
-  Oxygen application



Input pressure range										
Nominal pressure gauge	[bar]	16	25	40	60	100	160	250	400	600
Overpressure	[bar]	32	50	80	120	200	320	500	800	1200
Burst pressure \geq	[bar]	80	125	200	300	500	800	1400	2000	3000
Vacuum resistance		unlimited								

Contact ¹	
Number, type	standard: 1 PNP contact option: 2 independent PNP contacts 4 independent PNP contacts (possible with M12x1 8-pin for 4 ... 20 mA / 3-wire)
Max. switching current	4 ... 20 mA / 2- and 3-wire: contact rating 125 mA, short-circuit resistant; $V_{\text{switch}} = V_S - 2V$ 0 ... 10 V / 3-wire: contact rating 125 mA, short-circuit resistant
Accuracy of contacts ²	$\leq \pm 0.5\%$ FSO
Repeatability	$\leq \pm 0.1\%$ FSO
Switching frequency	max. 10 Hz
Switching cycles	$> 100 \times 10^6$
Delay time	0 ... 100 sec

¹ with IS-protection max. 1 contact possible

Analogue output (optionally) / Supply	
2-wire current signal	4 ... 20 mA / $V_S = 13 \dots 36 V_{DC}$ permissible load: $R_{\text{max}} = [(V_S - V_{S \text{ min}}) / 0.02 A] \Omega$ response time: < 10 msec
2-wire current signal with IS-protection	4 ... 20 mA / $V_S = 15 \dots 28 V_{DC}$ permissible load: $R_{\text{max}} = [(V_S - V_{S \text{ min}}) / 0.02 A] \Omega$ response time: < 10 msec
3-wire current signal	4 ... 20 mA / $V_S = 19 \dots 30 V_{DC}$ adjustable (turn-down of span up to 1:5) ³ permissible load: $R_{\text{max}} = 500 \Omega$ response time: < 0.5 sec
3-wire voltage signal	0 ... 10 V / $V_S = 15 \dots 36 V_{DC}$ permissible load: $R_{\text{min}} = 10 k\Omega$ response time: < 3 msec
Without analogue output	$V_S = 15 \dots 36 V_{DC}$
Accuracy ²	$\leq \pm 0.5\%$ FSO

² accuracy according to IEC 60770 – limit point adjustment (non-linearity, hysteresis, repeatability)

³ with turn-down of span the analogue signal is adjusted automatically to the new measuring range

Thermal effects (offset and span)	
Thermal error	$\pm 0.3\%$ FSO / 10 K
in compensated range	0 ... 70 °C

Permissible temperatures	
Medium	-40 ... 125 °C
Electronics / environment	-40 ... 85 °C
Storage	-40 ... 100 °C

Electrical protection	
Short-circuit protection	permanent
Reverse polarity protection	no damage, but also no function
Electromagnetic compatibility	emission and immunity according to EN 61326

Mechanical stability	
Vibration	10 g RMS (25 ... 2000 Hz) according to DIN EN 60068-2-6
Shock	500 g / 1 msec according to DIN EN 60068-2-27

Materials	
Pressure port	stainless steel 1.4571 (316 Ti)
Housing	stainless steel 1.4404 (316 L)
Display housing	PA 6.6, polycarbonate
Seals (media wetted)	none (welded)
Diaphragm	stainless steel 1.4542 (17-4PH)
Media wetted parts	pressure port, diaphragm

Explosion protection (only for 4 ... 20 mA / 2-wire)	
Approval AX14-DS 202	IBExU 06 ATEX 1050 X zone 1: II 2G Ex ia IIC T4 Gb (connector) / II 2G Ex ia IIB T4 Gb (cable)
Safety technical maximum values	$U_i = 28 V$, $I_i = 93 mA$, $P_i = 660 mW$, $C \approx 0 nF$, $L_i \approx 0 \mu H$
Max. switching current ⁴	70 mA
Permissible temperatures for environment	-25 ... 70 °C
Connecting cables (by factory)	cable capacitance: signal line/shield also signal line/signal line: 100 pF/m cable inductance: signal line/shield also signal line/signal line: 1 μH /m

⁴ the real switching current in the application depends on the power supply unit

Miscellaneous	
Display	4-digit, red 7-segment-LED display, digit height 7 mm, digit width 4.85 mm (angle 10°); range of indication -1999 ... +9999; accuracy 0.1 % ± 1 digit; digital damping 0.3 ... 30 sec (programmable); measured value update 0.0 ... 10 sec (programmable)
Current consumption (without contacts)	2-wire signal output current: max. 25 mA 3-wire signal output current: approx. 45 mA + signal current 3-wire signal output voltage: approx. 45 mA
Ingress protection	IP 65
Installation position	any
Weight	min. 160 g (depending on mechanical connection)
Operational life	100 million load cycles
CE-conformity	EMC Directive: 2014/30/EU Pressure Equipment Directive: 2014/68/EU (module A) ⁵
ATEX Directive	2014/34/EU

⁵ This directive is only valid for devices with maximum permissible overpressure > 200 bar

Wiring diagrams

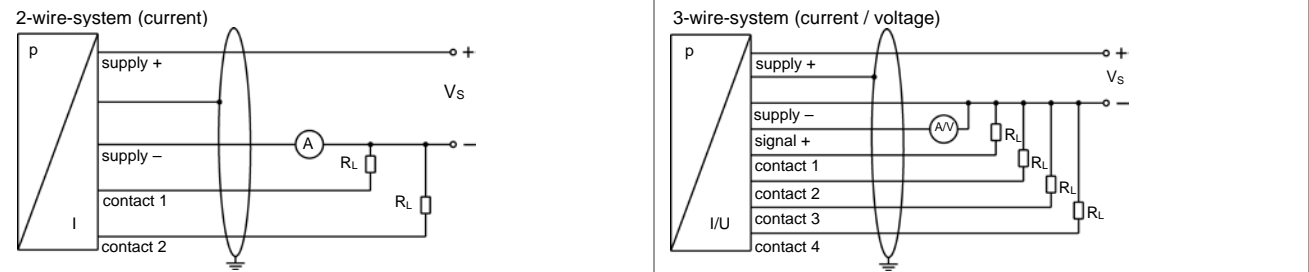

Pin configuration

Electrical connection	M12x1 plastic (5-pin)	M12x1 metal (5-pin)	M12x1 plastic (8-pin)	ISO 4400	Binder series 723 (5-pin)	cable colours (IEC 60757)
Supply +	1	1	1	1	1	WH (white)
Supply -	3	3	3	2	3	BN (brown)
Signal + (only 3-wire)	2	2	2	3	2	GN (green)
Contact 1	4	4	4	3	4	GY (grey)
Contact 2	5	5	5	-	5	PK (pink)
Contact 3	-	-	6	-	-	-
Contact 4	-	-	7	-	-	-
Shield	via pressure port	plug housing/ pressure port	via pressure port	ground contact	plug housing/ pressure port	GNYE (green-yellow)

Electrical connections (dimensions mm / in)

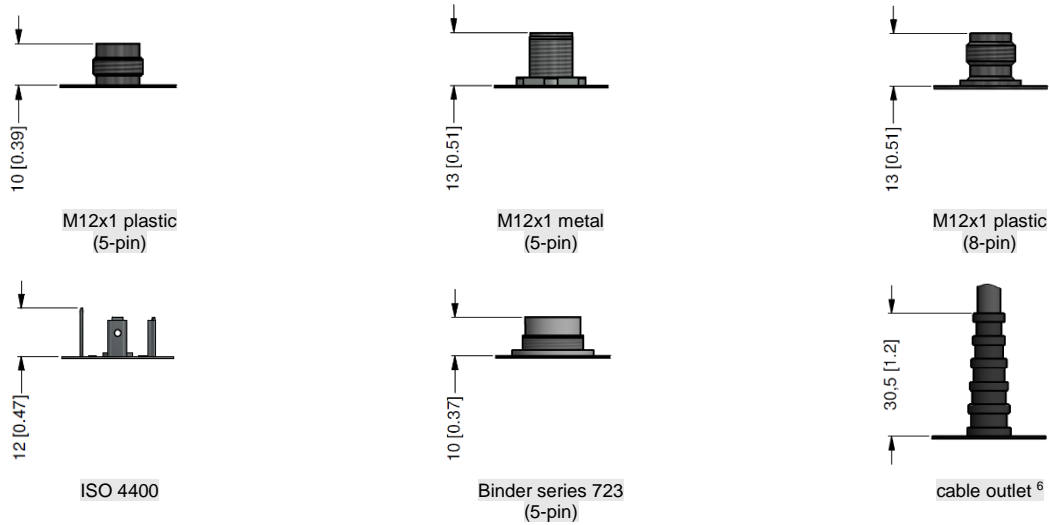

⁶ different cable types and lengths available; permissible temperature depends on kind of cable; standard: 2 m PVC cable (without ventilation tube, permissible temperature: -5 ... 70 °C)

Dimensions (mm / in)

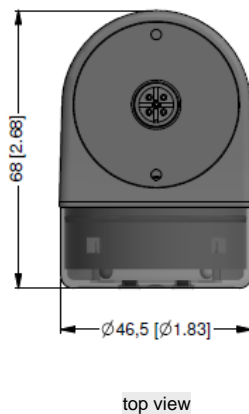
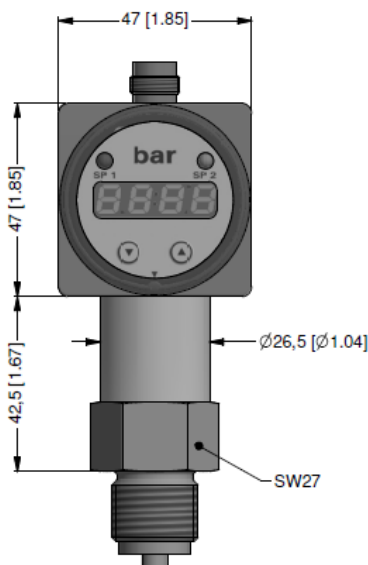

rotatability of display module

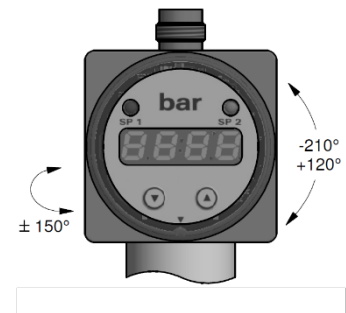

Mechanical connection (dimensions mm / in)

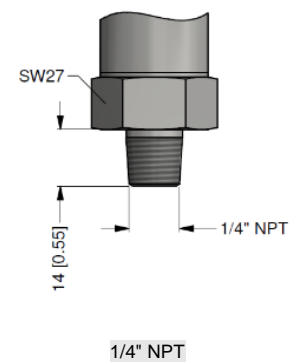
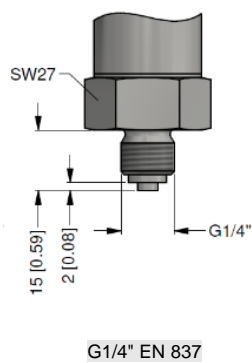
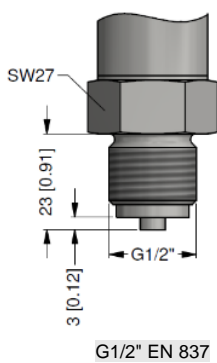

⇨ metric threads and other versions on request

© 2023 BD|SENSORS GmbH – The specifications given in this document represent the state of engineering at the time of publishing. We reserve the right to make modifications to the specifications and materials.

Ordering code DS 202

DS 202

□	□	□	□	-	□	□	□	□	-	□	-	□	-	□	□	□	-	□	□	□
---	---	---	---	---	---	---	---	---	---	---	---	---	---	---	---	---	---	---	---	---

Pressure	
gauge in bar ¹	7 8 4
Input	
[bar]	
16	1 6 0 2
25	2 5 0 2
40	4 0 0 2
60	6 0 0 2
100	1 0 0 3
160	1 6 0 3
250	2 5 0 3
400	4 0 0 3
600	6 0 0 3
customer	9 9 9 9
Analogue output	
without	0
4 ... 20 mA / 2-wire	1
0 ... 10 V / 3-wire	3
4 ... 20 mA / 3-wire	7
intrinsic safety 4 ... 20 mA / 2-wire ²	E
customer	9
Contact	
1 contact ²	1
2 contacts	2
4 contacts	4
Accuracy	
0.5 % FSO	5
customer	9
Electrical connection	
male plug M12x1 (5-pin) / plastic version	N 0 1
male plug M12x1 (8-pin) / plastic version ³	M 5 0
male plug M12x1 (5-pin) / metal version	N 1 1
male and female plug ISO 4400 ⁴	1 0 0
male plug Binder series 723 (5-pin)	2 0 4
cable outlet with PVC cable ⁵	T A 0
customer	9 9 9
Mechanical connection	
G1/2" EN 837	2 0 0
G1/4" EN 837	4 0 0
1/4" NPT	N 4 0
customer	9 9 9
Seal	
without (welded version)	2
customer	9
Special version	
standard	0 0 0
oxygen application	0 0 7
customer	9 9 9

¹ from 60 bar: measurement starts with ambient pressure

² with IS version max. 1 contact is possible

³ 4 contacts and M12x1, 8-pin only possible in combination and together with 4 ... 20 mA/3-wire; 0 ... 10 V/3-wire on request

⁴ with connector ISO 4400 and output 2-wire version only max. 1 contact possible; with 3-wire version no contact possible

⁵ standard: 2 m PVC cable without ventilation tube (permissible temperature: -5 ... 70 °C); others on request

© 2023 BD|SENSORS GmbH – The specifications given in this document represent the state of engineering at the time of publishing. We reserve the right to make modifications to the specifications and materials.