



**kelteks**



[kelteks.com/edgeprotector](http://kelteks.com/edgeprotector)



**build solid.**

**kelteks**

**EDGE PROTECTOR**

COMPOSITE REINFORCEMENT

REAL PROFESSIONALS  
DON'T MAKE WEAK PARTS...  
WHY WOULD YOU?

**build solid.**



Kelteks d.o.o.  
Dr. Slavka Rozgaja 3  
47000 Karlovac, Croatia - EU

✉ [info@solidian-kelteks.com](mailto:info@solidian-kelteks.com)  
🌐 [www.kelteks.com](http://www.kelteks.com)  
☎ P +385 47 693 300



# kelteks Edge Protector

NEW solution for perfect corner reinforcement

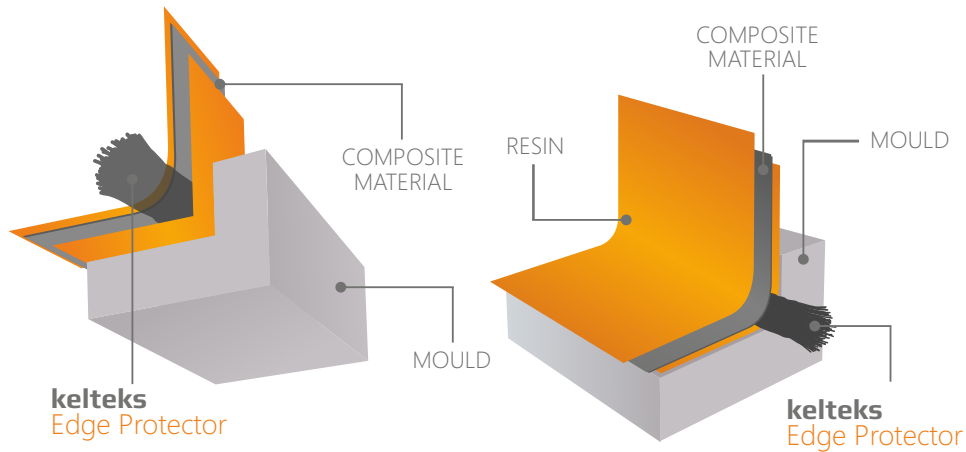

## What is the problem?

- There is always the problem that not enough glass fibers go into the sharp corners or edges with a small radius.
- Glass fiber mat usually would not stretch into the corner resulting in a "resin-nest" (too much resin) which is not reinforced with fibers. Sometimes air bubbles get trapped in there. These little voids are defects and weak spots, weakening the structural strength of your composite. After un-moulding this unreinforced corner is very sensitive to break, because there are no fibers inside (resin excess). The result is "stress cracking" and that almost always happen in radiuses of corners and edges.
- Products that are on the market are very hard and stiff and will not be squeezed into the corner, unless they are really precisely placed.

## We have a solution!

- The structure of the **kelteks Edge Protector** is fluffy and cuddly and is available in different thicknesses. It can be easily moulded and, as an insert in the preform, it adapts well to any contour. Fluffy and cuddly fibers are easily squeezed into the sharp-edged joints and corners. Check it out on youtube!
- Sharp-edged joints and corners in critical component areas are thus reliably filled with fibers and laminate chipping is effectively prevented.
- **kelteks Edge Protector** is suitable for all processes of composites making, such as hand lamination, vacuum infusion, pultrusion, etc.
- The transversely aligned entanglement fibers ensure a perfect bond to the overlying laminate layers.



### Long-lasting

Long life of the mould / composite part



### Fluffy

Super flexible and "fluffy" reinforcement yarn and yet easier to apply



### Reinforcement

Corners are reinforced with fibers (no resin-excess)



### Filling

During application fibers will be pressed into the smallest corner



### Connecting

Fibers will not resist overlaying glass fibre mat, but instead will connect to it



### No Maintenance

Less or no repair and maintenance cost

## variations

regular

**kelteks Edge Protector 50**

**kelteks Edge Protector 75**

**kelteks Edge Protector 100**

**kelteks Edge Protector 200**

soft

**kelteks Edge Protector 50 soft**

**kelteks Edge Protector 75 soft**

**kelteks Edge Protector 100 soft**

**kelteks Edge Protector 200 soft**

carbon

**kelteks Edge Protector C500**



kelteks Edge Protector



kelteks Edge Protector



kelteks Edge Protector

## applications

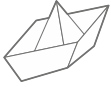

SHIPBUILDING  
REINFORCEMENT



WINDMILL BLADE  
REINFORCEMENT

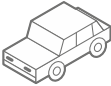

AUTOMOTIVE  
INDUSTRY



SPORT EQUIPMENT  
REINFORCEMENT

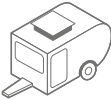

CAMPERS  
REINFORCEMENT

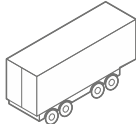

TRAILERS  
REINFORCEMENT

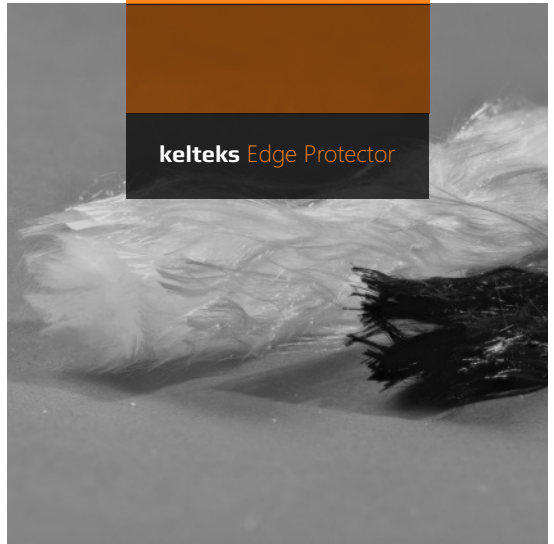

## technical information

- **kelteks Edge Protector** is compatible with epoxy (EP), polyester (UP), and vinyl ester (VE) resin.
- Made from high-quality carbon or glass fibers.
- Available in different diameters/thicknesses and lengths on a roll.
- Specially designed box for easy handling.



## Order Your Sample Now!

Try the regular or soft version and give us your feedback. Contact our sales and order your samples.

[sales@solidian-kelteks.com](mailto:sales@solidian-kelteks.com)



Scan or Click  
to watch technical videos about  
**keltex** Edge Protector

## Subscribe to **keltex** Youtube Channel

We often get asked about technical dimensions (like diameter, thickness...) of our Edge Protector, but the very fluffy and flexible nature of our product makes it difficult to be precise. And actually we want it that way, so that it squeezes naturally into the smallest corner to provide a good fiber reinforcement in your composite.

That is why we decided to make video, so that you can get an idea about how the product feels and which one fits best for your purpose.

However, the best way to get a solid grasp of the material properties is to order your own sample and feel it for yourself!

## HOW TO reinforce your composite edge

On our YouTube Channel, we made a video so that you can see the advantages and get an idea about the product application and usage.

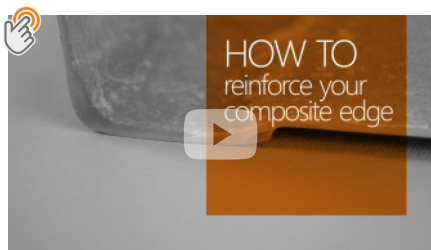

## GET A FEEL FOR **keltex** Edge Protector

Watch a technical video on the channel where you can see the dimensions of the **keltex** Edge Protector, its softness, and the ability to adjust the angles.

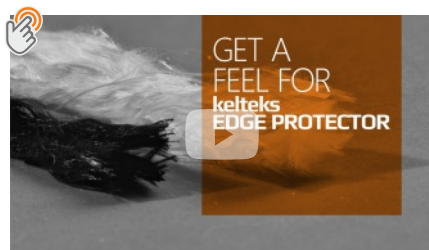

**build solid.**



Keltex d.o.o.  
Dr. Slavka Rozgaja 3  
47000 Karlovac, Croatia - EU

✉ info@solidian-keltex.com  
🌐 www.keltex.com  
☎ P +385 47 693 300



About **keltteks**

Your specialist for technical and functional  
textile development & manufacturing!

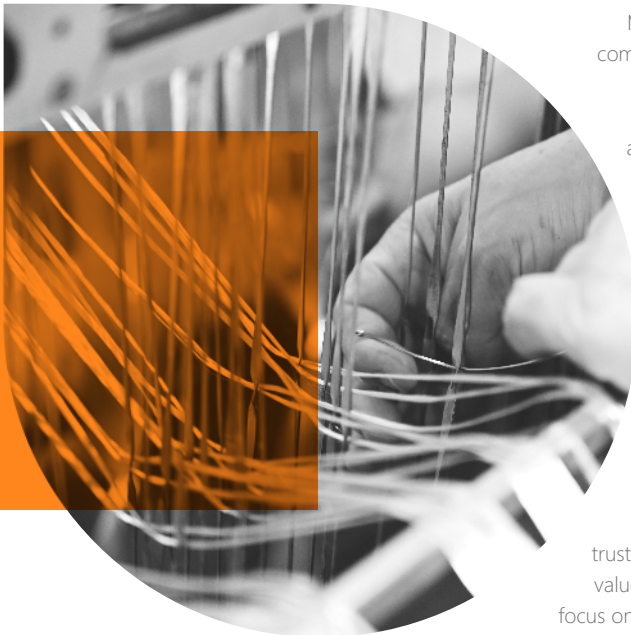
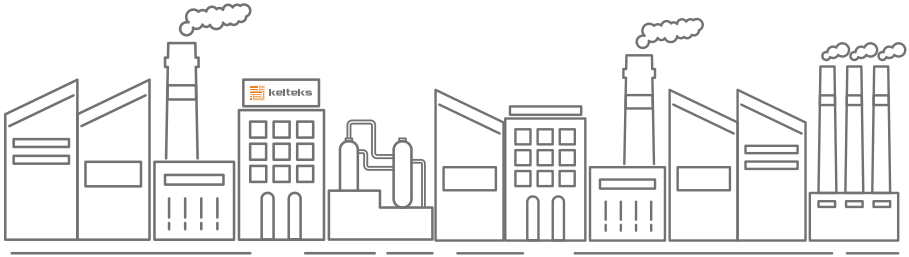

More than 30 years of experience in the composites industry as a manufacturer and developer of high-tech technical textile reinforcements for a large variety of applications. Our field of expertise is the large-scale production, with attention to every detail, of technical fibers such as carbon fibers, glass fibers, basalt fibers, etc., utilizing state of the art machinery and technology.

We are a family owned business and we are proud of the long experience of our 250 well trained, highly educated, and dedicated technical experts that ensure the best products and services for you. You can trust us to be your partner for the complete value chain of your product so that you can focus on your own business. Our 3 factories are located in the heart of Europe in beautiful Croatia, from where we supply our industrial customers in more than 30 countries. It goes without saying that we are certified according to DIN EN ISO 9001:2015 and DIN EN ISO 14001:2015

the  
**strongest link**  
in your composite

**build solid.**

# Other Products



check out our NEW website for more products and innovative solutions

[kelteks.com/products](http://kelteks.com/products)



**kelteks Cargo System**

is the solution based on our long-term industry experience. It is suitable for heavy loads and non-standard sizes because of its easily collapsible sidewalls. The heavy-duty construction of the container keeps fragile cargo protected and secured into position during transportation or when stored in warehouse.

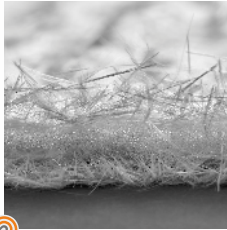

**kelteks FormMat**

consists of 2 layers of chopped fibers and 1 layer of a veil which saves you the time of work and preparation. High-volume fibers allow optimal coverage of critical areas. Especially suitable for the manufacture of parts that require mechanical properties

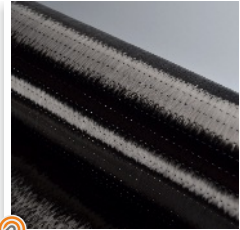

**kelteks Unidirectional**

Unidirectional (UD) fabric is one in which main, long, structural fibers are oriented in one direction, held in place by a secondary non-structural stitching threads. Structural orientation can be in 0 or 90°. Unidirectional fabrics are offering the ability to place fibers in the component exactly where it is required and in the optimum quantity.



**kelteks Woven Roving**

Strength and rigidity qualify carbon fibre reinforced plastics (CFRP) for all areas in which high mechanical loads occur, but the weight should remain low.

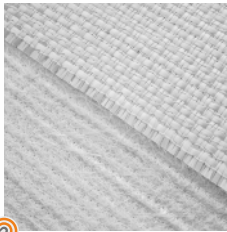

**kelteks Combimat**

We are producing Combimat in many different variations, a combination of fabric with veil (glass, polyester,...), mat (powder or emulsion) or a combination of two fabrics layer. Solutions are unlimited in our production.

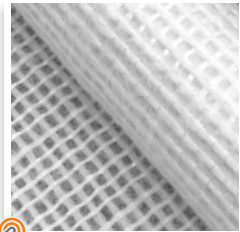

**kelteks Needled Fabrics**

We produce on our own specialized machines that we customized for the production of technical textiles. We are especially proud of the big variety of our specially developed high-performance needles. This, plus our in-house expertise, and highly trained employees can make any needed product for you.

**build solid.**



Kelteks d.o.o.  
Dr. Slavka Rozgaja 3  
47000 Karlovac, Croatia - EU

✉ [info@solidian-kelteks.com](mailto:info@solidian-kelteks.com)  
🌐 [www.kelteks.com](http://www.kelteks.com)  
☎ +385 47 693 300

**30**  
YEARS OF INNOVATIONS  
EST. 1990

