



# SmartVane

Revolutionary vacuum pump for mass spectrometers with hermetically sealed pump housing



Medical Technology



Analysis

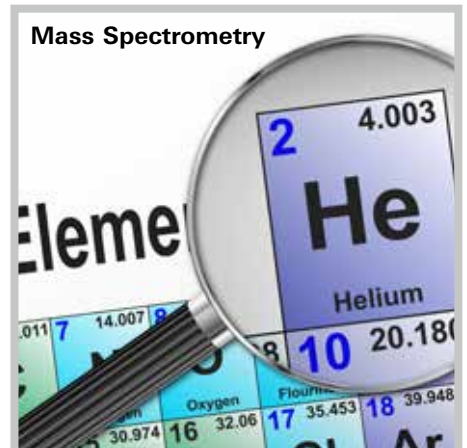

Mass Spectrometry

# SmartVane

Revolutionary vacuum pump for mass spectrometers with hermetically sealed pump housing



No oil leakage

Your added value



Low noise level

## Hermetically sealed pump housing

The SmartVane is the first rotary vane pump for mass spectrometry with a hermetically sealed pump housing. By omitting shaft seals, it eliminates the main cause of oil leakage. As a result, the SmartVane combines the advantages of the proven rotary vane pump principle with a revolutionary sealed design. This makes it ideal as a backing pump for mass spectrometers in the fields of environmental and food analysis as well as pharmaceutical and clinical analysis.

## Ideal for laboratory use

With its low noise level, the SmartVane ensures optimal conditions in the laboratory. At its typical operating pressure of <math><10\text{ hPa}</math>, it is quieter than other pumps in this application area. This means that even challenging tasks can be completed in a pleasant working environment. Another advantage point is that the SmartVane's compact design makes it easy to install in existing systems. As a plug and play solution, it can be easily connected to already installed equipment. Thanks to intelligent communication options, the SmartVane conveniently corresponds with your system.

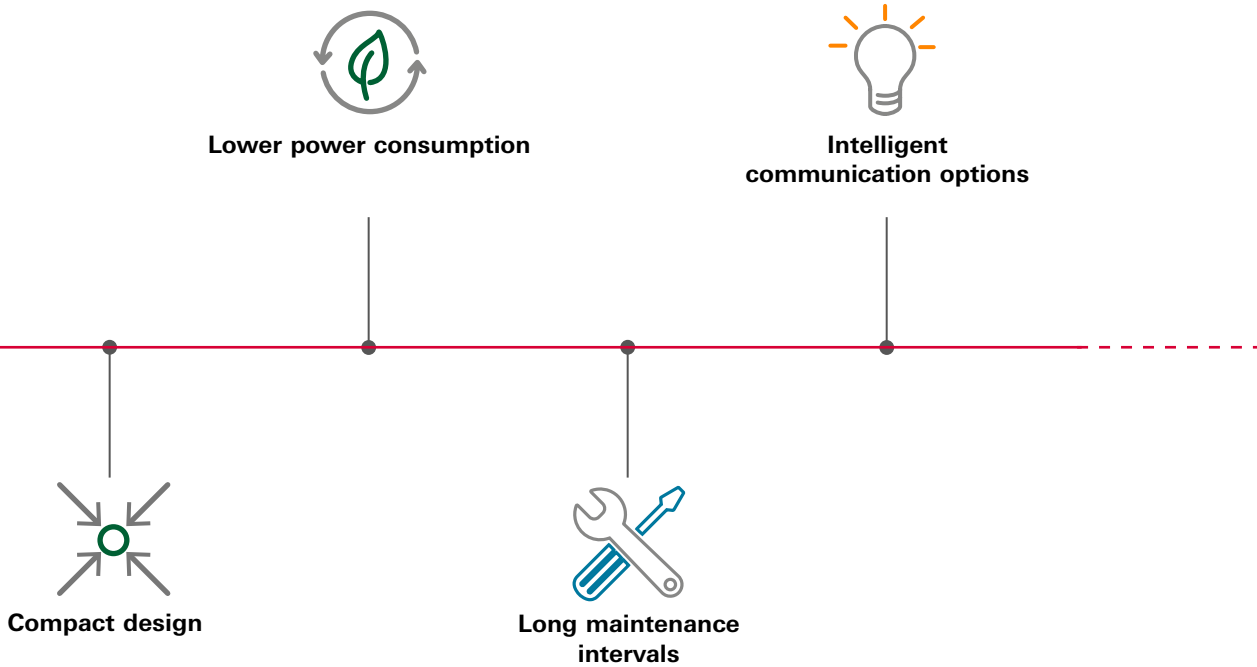

### Environmentally friendly and low maintenance

The SmartVane incorporates an energy-efficient IPM motor with standby function. Its low power consumption automatically lowers operating costs and reduces the carbon footprint. The integrated motor also enables the special design that makes a conventional seal with shaft seals obsolete. As a result, you benefit from maintenance intervals of up to two years.

### Applications

- ICP-MS
- LC/MS
- Backing pump for turbopumps

# SmartVane

Revolutionary vacuum pump for mass spectrometers with hermetically sealed pump housing

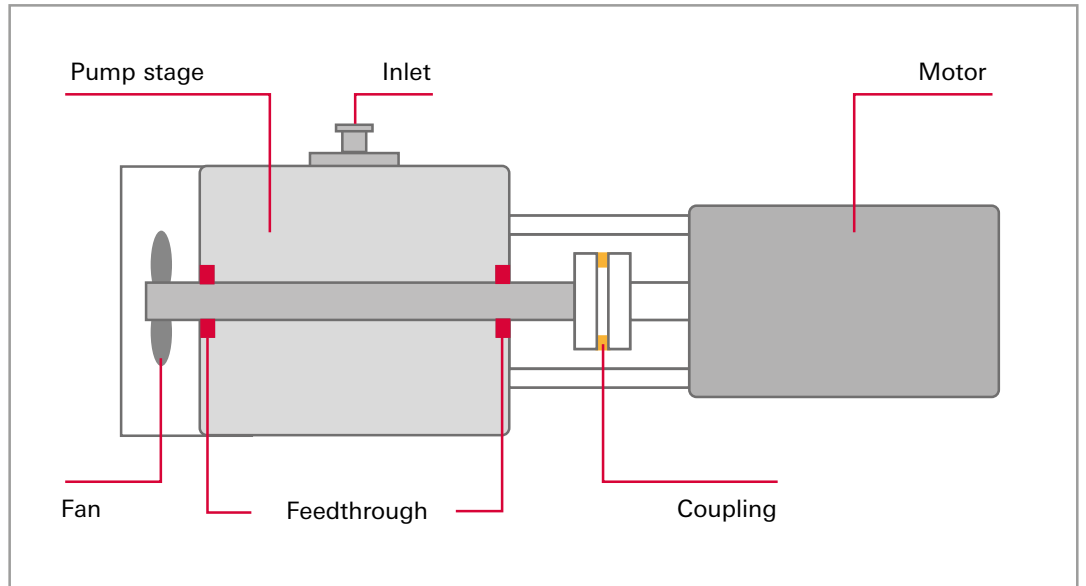

Conventional pump design, before SmartVane

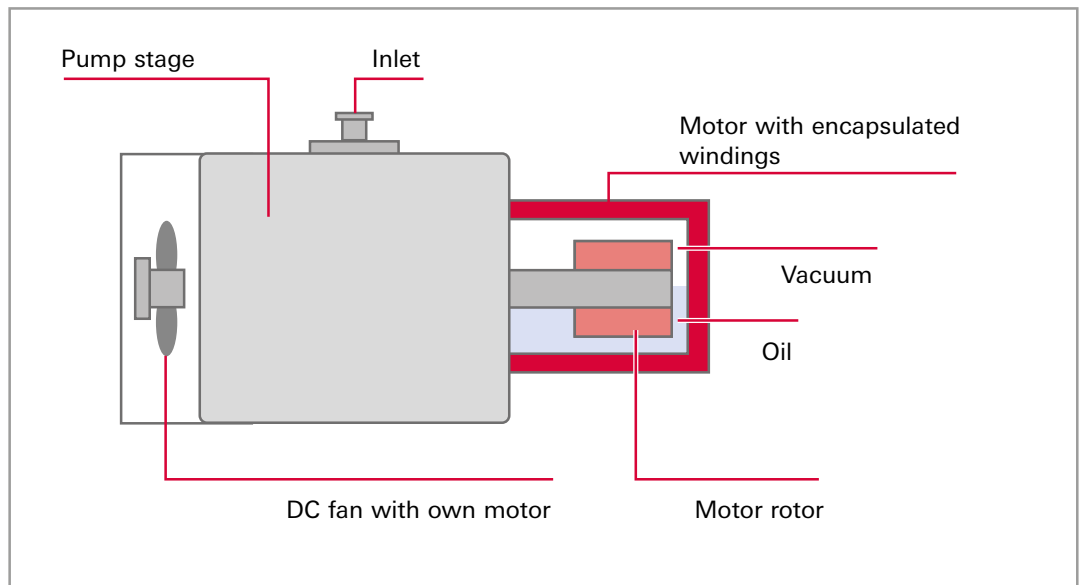

Pump design SmartVane

# We drive sustainable solutions

## Environmentally friendly

By using novel IPM<sup>1)</sup> synchronous motors with sensorless INFORM<sup>®</sup> control<sup>2)</sup>, our SmartVane pumps achieve environmentally friendly efficiency. Reducing power requirements while maintaining high pumping capacity results in lower operating costs for the operator while the motor achieves premium efficiency and significantly exceeds the minimum values of efficiency level IE3 as applicable to standard asynchronous motors. Everyone benefits from this.

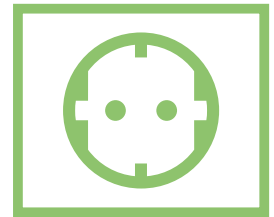

In addition, the use of the new IPM motor technology results in significantly smaller product dimensions compared to products using asynchronous motors.



## Conserving resources

However, the pump's performance and installation dimensions are not the only environmental benefits. Our SmartVane already scores points in production through conscious material savings. For example, less copper is used and advanced technologies eliminate the need for additional sensors. The pump housing, like the hood and the housing of the electronics, is manufactured by casting, which avoids excessive production waste.



## Sustainable

Last but not least, man and machine benefit equally from sustainable use of state-of-the-art technologies: The new-generation rotary vane pumps emit less waste heat and also have a longer service life thanks to innovative standby operation. They run extremely quietly and with low vibration, making their working environment safe and comfortable.



<sup>1)</sup> Interior Permanent Magnet

<sup>2)</sup> INFORM<sup>®</sup> process according to Prof. Schrödl

# SmartVane

Technical data, dimensions, order numbers, accessories

## Pumping speed

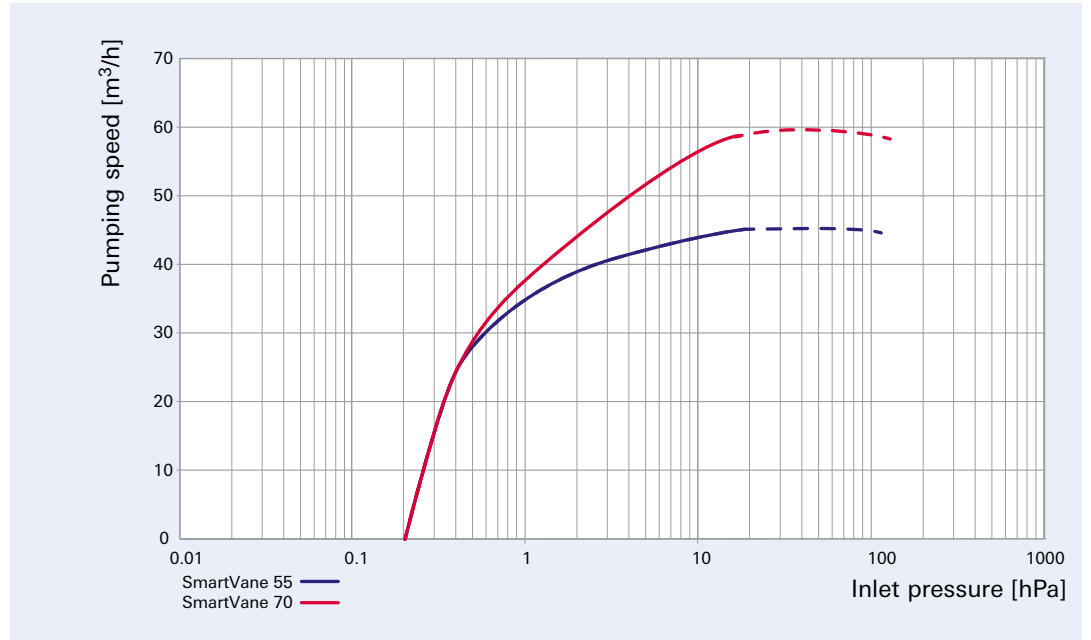

## Dimensions

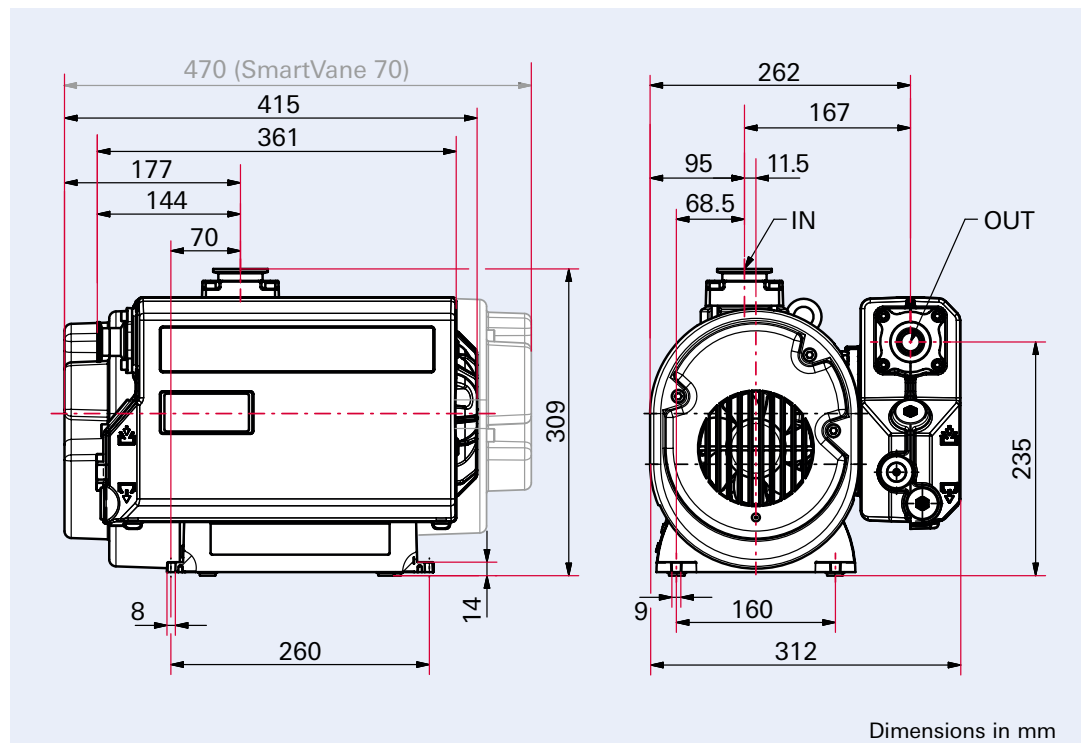

**Technical data**

	SmartVane 55	SmartVane 70
Nominal pumping speed	31–50 m <sup>3</sup> /h	31–70 m <sup>3</sup> /h
Ultimate pressure without gas ballast	2 · 10 <sup>-1</sup> hPa	
Input voltage	100–127 V / 200–240 V AC (±10), 50/60 Hz	
Motor protection	Internal	
Motor type	1-ph motor	
I/O interfaces	RS-485; I/O port	
Leakage rate of check valve	1 · 10 <sup>-2</sup> Pa m <sup>3</sup> /s	
Dimensions (L x W x H)	415 x 312 x 308 mm	470 x 312 x 308 mm
Rated power at maximum speed	0.75 kW	1 kW
Protection class	IP20	
Certifications	CE, cTUVus	
Cooling type	Air	
Ambient temperature	15–45 °C	
Continuous gas inlet temperature, max.	40 °C	
Connection flange (inlet)	DN 40 ISO-KF	
Connection flange (outlet)	DN 25 ISO-KF / G1/2	
Continuous inlet pressure, max.	15 hPa	
Exhaust pressure, min./max.	Atmospheric pressure	
Weight	36 kg	37 kg
Input voltage: tolerance (%)	10 %	
Mains cable included	No	
Mains cable	No, C16 connector in terminal box	
Gas ballast	No	
Operating medium	H1 / F4	
Operating medium quantity	1.75 l	
Operating height, max.	4,000 m	
Speed	800–1350 rpm	800–1800 rpm

SmartVane

**4.000 m**  
Operating altitude

**100 - 127 V /  
200 - 240 V**  
Input voltage

**Order numbers**

	SmartVane 55	SmartVane 70
With operating medium H1	<b>PK D80 000</b>	<b>PK D81 000</b>
With equipment F4	<b>PK D80 001</b>	<b>PK D81 001</b>

**Accessories**

Accessories	Order number
FAK 040, activated carbon filter	<b>PK Z30 008</b>
SAS 40, dust separator	<b>PK Z60 510</b>
Mains cable 230 V AC, CEE 7/7 to C15, 3 m	<b>PK 050 343</b>
Mains cable 110 V AC, NEMA 5-15 to C15, 3 m	<b>PK 050 344</b>
Y-distributor M12 for RS-485	<b>P 4723 010</b>
Adapter RS-485 to M12	<b>PE 100 150-X</b>
OmniControl 001 mobile, control units	<b>PE D20 000 0</b>
OmniControl 001 mobile, rack unit without integrated power supply unit	<b>PE D40 000 0</b>
Interface cable RJ 45 to M12	<b>PM 051 726-T</b>
USB RS-485 converter	<b>PM 061 207-T</b>
Interface cable, M12 m straight / M12 m straight, 3 m	<b>PM 061 283-T</b>

Operating fluid	Order number
H1, 1 l	<b>PK 001 210-T</b>
F4, perflour polyether, 0.25 l	<b>PK 005 885-T</b>
F4, perflour polyether, 0.5 l	<b>PK 005 886-T</b>
F4, Perflour polyether, 1 l	<b>PK 005 887-T</b>

Further accessories can be found on our website at [www.pfeiffer-vacuum.com](http://www.pfeiffer-vacuum.com).

## Your Success. Our Passion.

We give our best for you every day –  
worldwide!

Are you looking for an  
optimal vacuum solution?  
Please contact us:

**Pfeiffer Vacuum GmbH**  
Germany  
T +49 6441 802-0



Errors excepted. All data subject to change without prior notice. PD 0065 PEN (November 2022/PoD)

Follow us on social media  
#pfeiffervacuum



[www.pfeiffer-vacuum.com](http://www.pfeiffer-vacuum.com)

