

Slip Rings

ROTOFLUX® • ROTOCAP® • ROTORAY® • ROTOKOMBI®

A Good Connection



GAT®

Gesellschaft für
Antriebstechnik mbH

Our Company



GAT – Gesellschaft für Antriebstechnik mbH headquartered in Geisenheim, Germany, is a leading international technology venture, engineering and producing tailored products for the most diverse industry applications in the electrotechnical transmission technology as well as fluid and sealing technology sectors for more than 30 years.

The company is the technology leader in the field of rotary unions, electrical slip rings, precision air bearings, test rig equipment as well as special equipment.

Our team of highly qualified engineers and product specialists offers competent expert advice responding to the requirements and needs of our customers, choosing from our wide range of products to find a standard or individual, custom-made solution.

We design, produce and distribute high-tech precision products used in machine and plant engineering as well as energy generation worldwide.

Our product specialists based in 18 sales offices around the world offer our customers competent technical advice, taking economic considerations into account on a professional level, thereby contributing to our customers' success.

Our Competence

Being an innovative company meeting the challenge of the ever faster increasing requirements of modern technologies, GAT and their employees are constantly further developing their equipment and products.

Our rotary unions and slip rings reflect our broad technological know-how in conjunction with innovation and process optimization as well as our many years of experience in this business field.

GAT delivers complete systems from a single source and is the only manufacturer worldwide that designs, produces and distributes slip rings and rotary unions in-house. This guarantees optimal support for our customers, from conceptual to design phase and up until the end product.

All our customers benefit from certified quality and short delivery times. Our after sales service ensures support for our customers worldwide.

Customer satisfaction always comes first for us. We trust in long-term, reliable, confiding and fair cooperation.

A Good Connection



GAT[®]
Gesellschaft für
Antriebstechnik mbH



Wind turbines



Packaging systems



Seismic measuring systems

Applications

Over the years GAT has developed a whole range of slip rings for the most diverse applications in many industry sectors, be it industry-specific or as individual solutions.

All our slip rings of the model ranges ROTOFLUX[®], ROTOCAP[®], ROTORAY[®] and ROTOKOMBI[®] share the same level of performance, precision, quality, long service life and economic efficiency.

In addition to our long tried-and-proven ROTOFLUX[®] series of slip rings for contacting transmission, we also offer solutions for non-contacting data transmission at highest data rates. Both slip rings types can be combined with GAT media rotary unions for the transmission of oil, air, water and gases as required.

The products are used in a variety of industries and sectors, e.g. machine tool manufacturing and automotive production, rolling mills, petroleum and semiconductor industry, aircraft industry, tunnel-boring, seismic measuring systems, medical engineering, packaging industry and wind energy.

We support you in finding the optimal product for your specific application.



Medical technology



Automotive industry



Machine tools

ROTOFLUX® Contacting Slip Rings

Due to their modular design, slip rings of the ROTOFLUX® series are very flexible and can therefore be adapted to customer-specific requirements very easily.

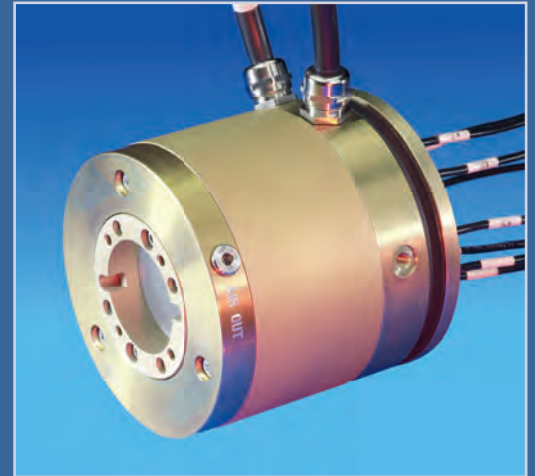

Our slip rings are used to transmit digital signals (via field bus systems or Ethernet) and also high-resolution analog measuring signals or high currents. In order to ensure a reliable transmission we have been using our proven gold/gold technology for years. Thanks to the pairing of gold spring wires and gold-plated slide contacts, our slip rings exhibit excellent characteristics for the transfer of power currents, signals and data. The ROTOFLUX® series slip rings can be combined with any GAT media rotary unions.

ROTOFLUX® ESR Slip Rings

The contacting slip rings of the ESR series are very compact and designed for axial installation. All slip rings of this design are also available with an integrated air duct.

ROTOFLUX® ESW Slip Rings

The ESW series slip rings offer an inner diameter of 25 – 525 mm.

Product Features

- Very safe and reliable transmission of signal, data streams, and high currents
- Communication via field bus systems and Ethernet
- Compact design with robust aluminum or steel housing
- Sealed ball bearings
- Extremely low electrical noise
- Highest contact quality
- Very low contact resistance
- Maintenance-free, long service life
- High operational reliability even when subjected to vibrations and extreme temperatures
- Compatible with GAT media rotary unions

Gold/gold transmission technology

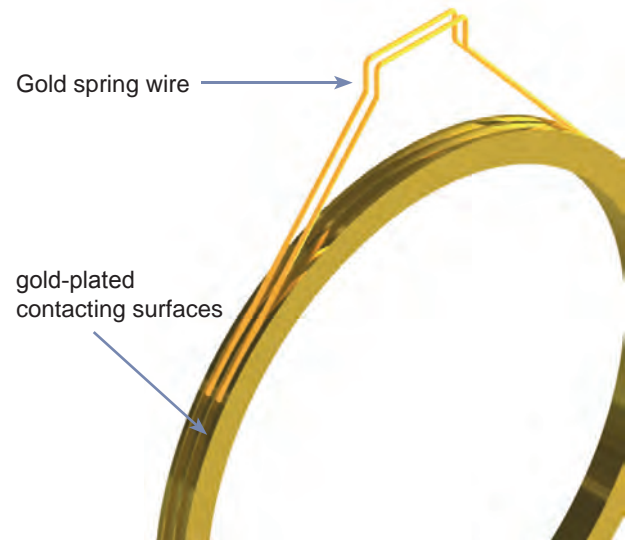

Challenge us



GAT[®]
Gesellschaft für
Antriebstechnik mbH

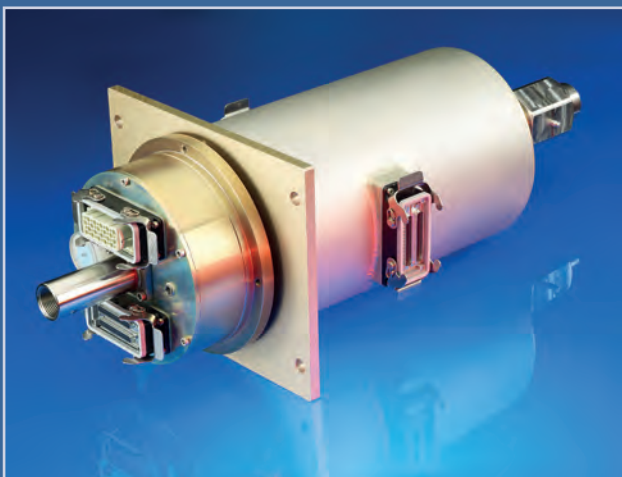

Technical Data ROTOFLUX[®] ESR

Type	ESR 70	ESR 110	ESR160
Housing outer diameter Ø (mm) other housing diameters available	70	110	160
Number of poles, max.	32	48	80
Rated current, max. (A)	20	40	50
Speed, max. (rpm)	500	250	100
Air connection ("), optional other connection sizes available	G ½ / G ¼	G¾ / G ½	G 1
Air pressure, max. (bar)	10		
Installation position	vertical / horizontal		
Protection class	up to IP 65		

Technical Data ROTOFLUX[®] ESW

Type	ESW 110	ESW 140	ESW 200	ESW 300	ESW 400	ESW 525
Free inner diameter Ø, max. (mm)	35	55	100	160	275	395
Housing outer diameter Ø (mm) other housing diameters available	110	140	200	300	400	525
Number of poles, max.	80	80	100	150	150	50
Rated current, max. (A)	60	60	60	200	240	60
Speed max. (rpm)	250	250	100	50	50	30
Installation position	vertical / horizontal					
Protection class	up to IP 65					

Custom products and designs such as devices with larger dimensions, explosion-proof versions or high-speed models are also available.



ROTOCAP® Non-contacting Transmission Technology

ROTOCAP® is a slip ring combination with non-contacting capacitive high-speed data transmission.

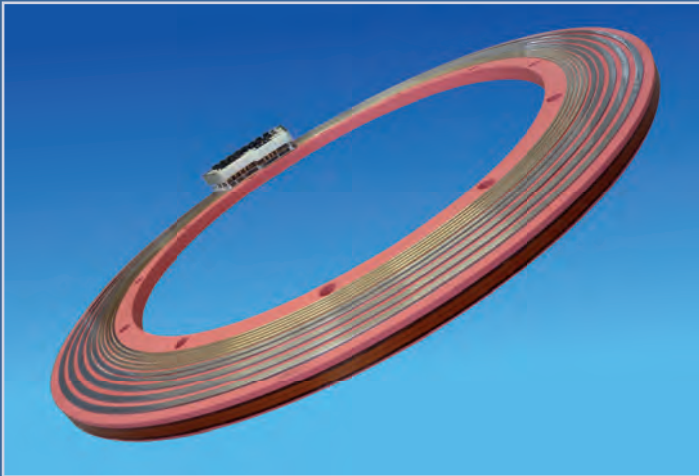

The continuously increasing transmission rates in many application areas require high-capacity transmission systems able to handle highest data rates. Being highly resistant against electromagnetic interference, our capacitive slip ring combination ROTOCAP® ensures a reliable high-speed data transmission even in environments with strong electric and magnetic interference. The capacitive slip ring systems ROTOCAP® are used in packaging industry, wind turbines, automotive industry, medical equipment, etc.

The data transmission is based on capacitive non-contacting transmission technology. The product line ROTOCAP® Ethernet supports bidirectional high-speed data transmission between fixed and rotating parts at bit-error rates better than 10^{-12} .

Thanks to the modular design of this capacitive slip ring system, multiple channels can be used simultaneously and bidirectionally. The special design of the ROTOCAP® Ethernet has been adapted to the requirements of all standard Fast Ethernet 100BASE-TX based transmission protocols (Profinet, Powerlink, Sercos III, etc.). Due to the internal clock recovery and signal amplification a very low noise signal is ensured.

The slip ring combination ROTOCAP® also supports the transmission of power and sensors by the integrated contacting gold/gold technology. Another benefit is the possible combination with GAT media rotary unions. Larger diameters up to 2 meters are also available.

Product Features

- Non-contacting, capacitive data transmission
- 100 Mbit/s Fast Ethernet and Profinet transmission
- Combined with contacting gold/gold technology
- Bit error rate $< 10^{-12}$
- High resistance against EMI and ESD
- Maintenance-free Slip Ring
- Compatible with GAT rotary unions for media
- Free inner diameter possible
- Larger diameters up to 2 m possible

Contactless, capacitive transmission technology

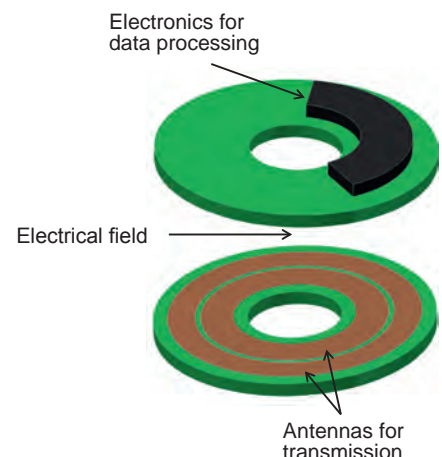

Data Transmission Takes a New Turn with GAT



GAT[®]
Gesellschaft für
Antriebstechnik mbH



Technical Data ROTOCAP[®]

Type ROTOCAP [®]	Non contacting
Housing outer diameter Ø (mm)	160...
Number of Ethernet paths	1...4
Transmission standard and supported protocols	100 BASE-TX (Fast Ethernet, Profinet, POWERLINK, Sercos III, etc.)
Bit error rate (max.)	< 10 ⁻¹²
Latency (µs)	< 2
Supply voltage (VDC)	5
Operating Temperature range (°C)	- 40 to + 80
Typical lifespan (mil. rotations)	100
Maintenance interval (mil. rotations)	Maintenance-free
Air connection (" optional)	G ³ / ₈ or G ¹ / ₂
Air pressure max. (bar)	10

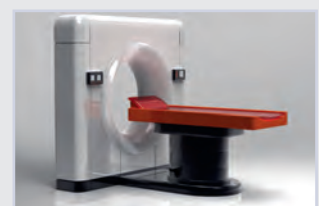
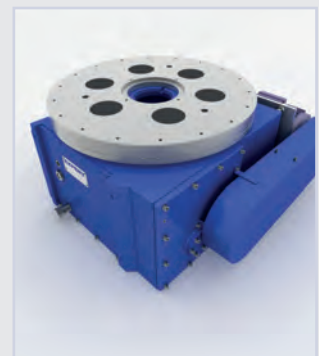

ROTORAY® Optical Transmission Technology

The ROTORAY® fiber-optical rotary union for high-speed data transmission is very robust, extremely efficient and highly precise.



It enables contactless bidirectional high-speed signal transmission between a fixed and a rotating component whilst offering various benefits such as robust design, very low insertion loss, insensitivity to temperature fluctuations and vibrations as well as a data transmission rate of up to 30 Gbit/s.

A new ultra-precise adjusting process developed by GAT along with our innovative technology for positioning the optical components ensure an impressive optical efficiency, fulfilling the basic prerequisites for contactless bidirectional high-speed data transmission.

ROTORAY® is available with single-mode and multi-mode fiber optics. Typical ROTORAY® areas of application include the offshore, marine and energy sectors. In addition, the fiber-optical rotary union ensures reliable high-speed data transmission in medical systems, wind power systems and safety systems.

Product Features

- Data transmission rates up to 30 Gbit/s
- Immune against EMI and ESD
- Very low insertion loss
- Extremely robust design
- Optical performance insensitive to temperature fluctuations
- Easily upgradeable to multichannel system
- Available both as single component with very compact design or in combination with GAT slip rings and media rotary unions

Optical transmission technology

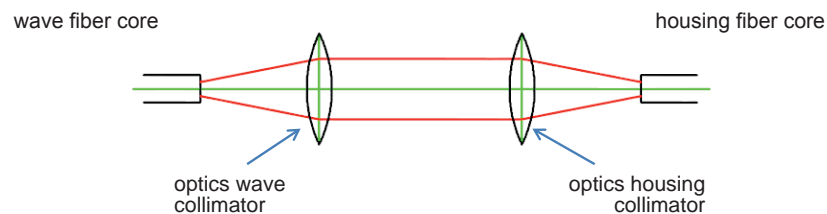

Data at the Speed of Light



GAT[®]
Gesellschaft für
Antriebstechnik mbH

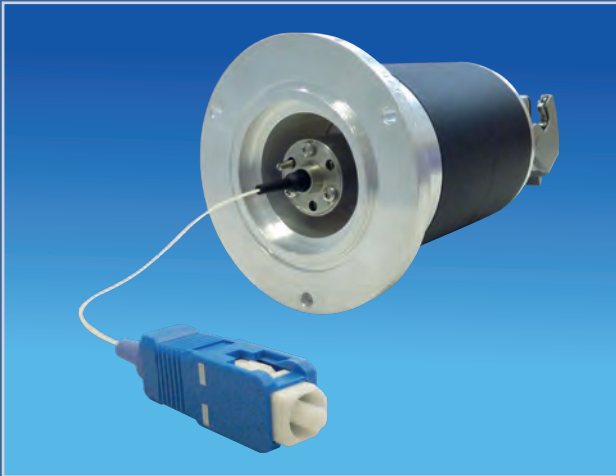

Technical Data ROTORAY[®]

Type	ROTORAY [®] SM1	ROTORAY [®] MM1
Fiber types (µm)	Single Mode 9 /125	Multi Mode 62,5 /125 Multi Mode 50 /125
Wavelength range (nm)	1,310 - 1,650	850 - 1,580
Insertion loss (dB)	< 2.0	< 1.5
Dynamic insertion loss variation (dB)	< 0.5	< 0.5
Back reflection (dB)	FC/PC - 35 FC/APC - 40	FC/PC - 15 PC/APC - 20
Connector types	FC/PC or FC/APC	FC/PC or ST/PC
Operating temperature (°C)	- 40 to + 80	- 40 to + 80
Housing diameter (mm)	25	25
Rational speed (rpm)	10,000	
Housing material	Stainless steel	



ROKOMBBI® Combinations without Limits

GAT is the technology leader in the design and production of media rotary unions and of contacting and non-contacting slip ring systems. We are a single-source supplier for standard solutions as well as custom-made products, all developed in-house.

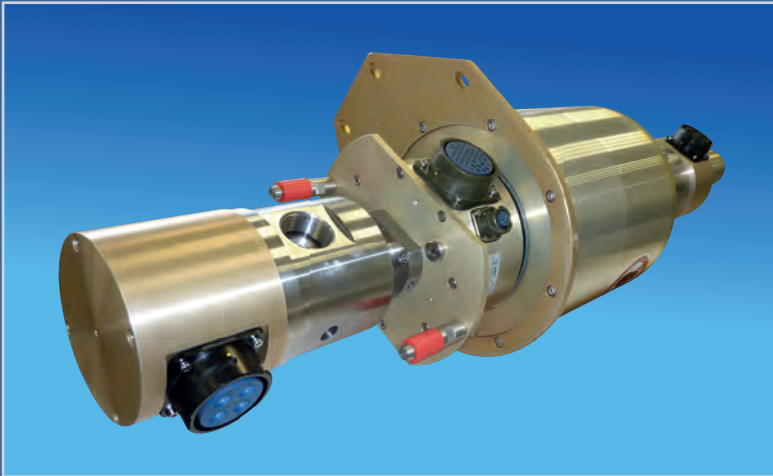

This comprehensive approach ensures that an optimally adapted sealing system is available for any medium. Our product specialists and engineers design individual solutions according to customer requirements, relying on tried and tested systems and components.

Our expertise both in fluid and sealing technology as well as electrical transmission technology represents a competitive edge, enabling us to design unique high-tech products based on specialist know-how and many years of experience.

The transmission component of the slip ring can be designed as a redundant system to increase data transmission reliability. By using our different data transmission technologies, an asymmetric redundancy with an extremely high level of safety is ensured. This solution increases plant availability in a targeted and sustainable way.

Product Features

- Complete system from a single source
- Modular design
- Easy replacement of individual components thanks to quick-change system
- Matching interfaces for all components
- Simultaneous transmission of electrical currents, signals and media such as air, water, oil, coolant, grease, vacuum, etc. at high or low rotational speeds
- Reliable communication via field bus systems and Ethernet
- Sealing systems requiring minimal maintenance
- Maintenance-free slip ring systems
- Very simple to adapt to plant or machine

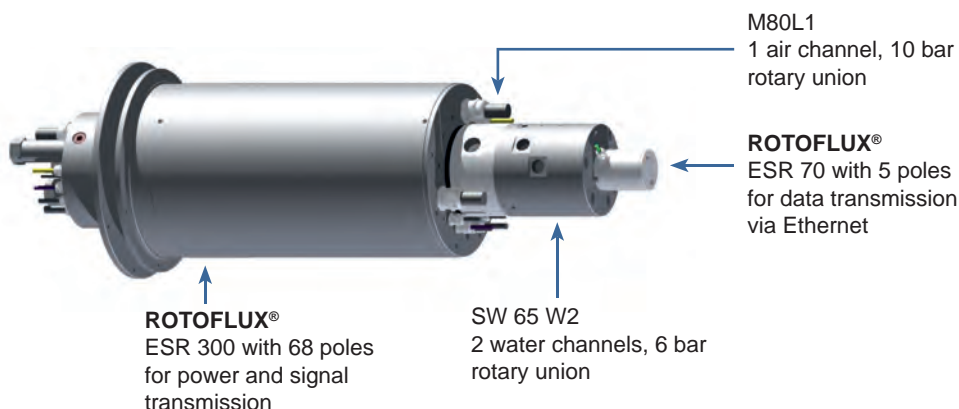

Everything from a Single Source



GAT[®]
Gesellschaft für
Antriebstechnik mbH

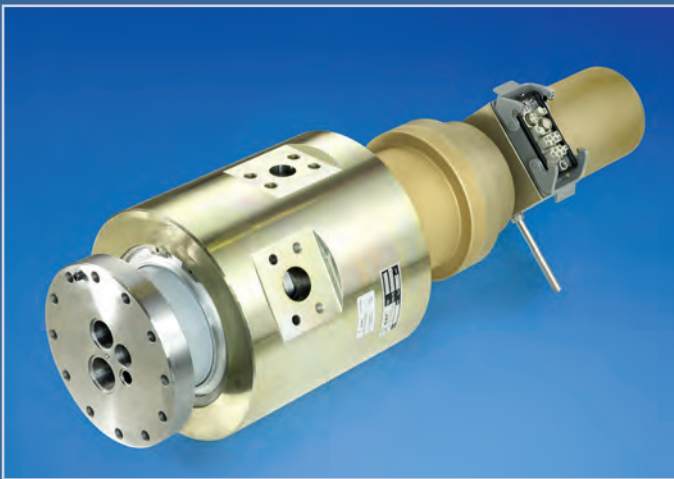

Slip Ring Accessories

ROTOFLUX[®] • ROTOCAP[®] • ROTORAY[®] • ROTOKOMBI[®]

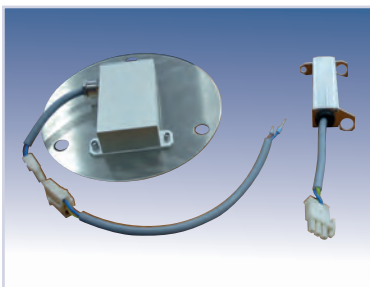

Heaters



Plug-type connector variants



Coupling variants



Angular transmitter with coupling



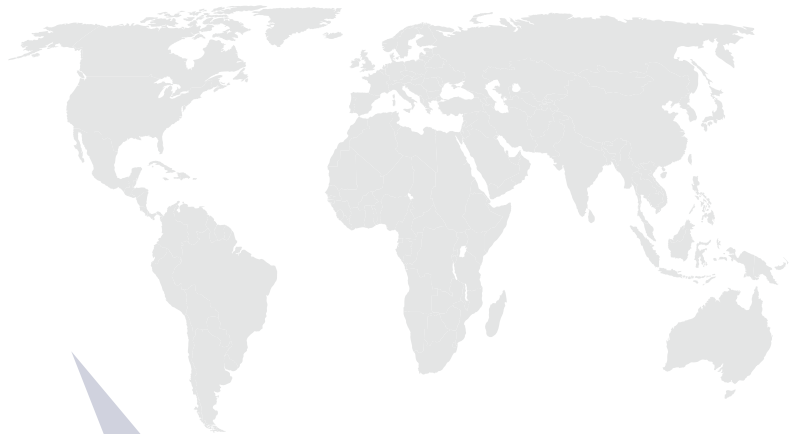

Our Product Portfolio

- Rotary Unions
- Electrical Slip Rings
- Precision Air Bearings
- Test Rig Technology
- Special Equipment



GUARANTEED QUALITY MANAGEMENT
GAT - Gesellschaft für
Antriebstechnik mbH



GAT[®]
Gesellschaft für
Antriebstechnik mbH

GAT - Gesellschaft für
Antriebstechnik mbH
Industriestraße 11
65366 Geisenheim - Germany

Phone: +49 (0) 6722 93788-0
Fax: +49 (0) 6722 93788-110
Email: info@gat-mbh.de
Internet: www.gat-mbh.de