

Specification

Model ^{※1}	Unit	Master 20s/20	Master 25s/25	Master 30s/30	Master 35s/35	Master 40s/40	Master 45	Master 50	Master 60	Master 70	Master 80	
Power input ^{※2}		AC 220V, 50 / 60Hz, 3 phase										
Travel drive method		Rack & Pinion										
Longitudinal rail		Grinding I-rail										
Transverse rail		Double linear way										
Overall width (A)	mm	3,000	3,500	4,000	4,500	5,000	5,500	6,000	7,000	8,000	9,000	
Overall height (B)	mm	1,950					2,000					
Overall depth (C)	mm	1,500					2,000					
Cutting width (D)	mm	1,600	2,100	2,600	3,100	3,600	4,100	4,600	5,600	6,600	7,600	
Rail gauge ^{※3} (E)	mm	2,000	2,500	3,000	3,500	4,000	4,500	5,000	6,000	7,000	8,000	
Parking space	mm	1,500					2,000					
Cutting speed	m/min	8 / 12 / 16 ^{※4}							12 / 16 ^{※4}		8 / 12 ^{※4}	
Traveling speed	m/min	12 / 16 / 24 ^{※4}							16 / 24 ^{※4}		12 / 16 ^{※4}	
Min. distance between 2 torches	mm	100										
Track length (section)	mm	3,000										
Weight	kg	1,230	1,275	1,330	1,540	1,600	1,660	2,100	2,200	2,400	2,550	

※1 Master 20s / 25s / 30s / 40s is single drive on longitudinal axis
 ※2 Special requirement available
 ※3 Special rail gauge available
 ※4 Optional high speed driver

*Specifications subject to change without notice

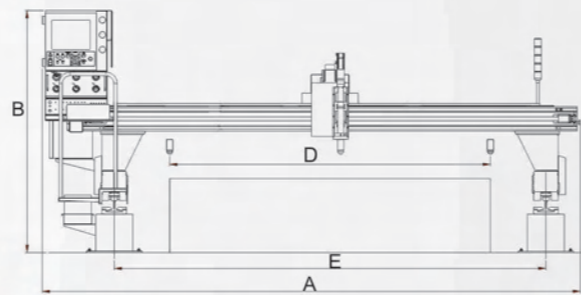
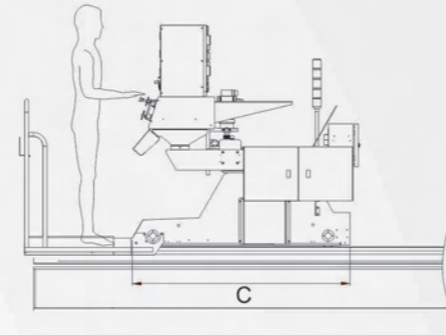

聯祥企業股份有限公司
 UNITED PROARC CORPORATION

No.3 Gungye 10th Rd., Pingjen Industrial Park, Pingjen Dist.,
 Taoyuan City 32459, Taiwan
 Phone: +886 3 469 6600 Fax: +886 3 4694499
 E-mail: sales@proarc.com.tw <http://www.proarc.com.tw>

We love metal arts
 welding · cutting · drilling ······ since 1966

Master

plasma and flame CNC cutting machine



SINCE 1966

Constant innovation is ProArc's core value

In order to provide best products to our customers, ProArc is constantly doing research and development. Seeking better solution is what we always pursue.

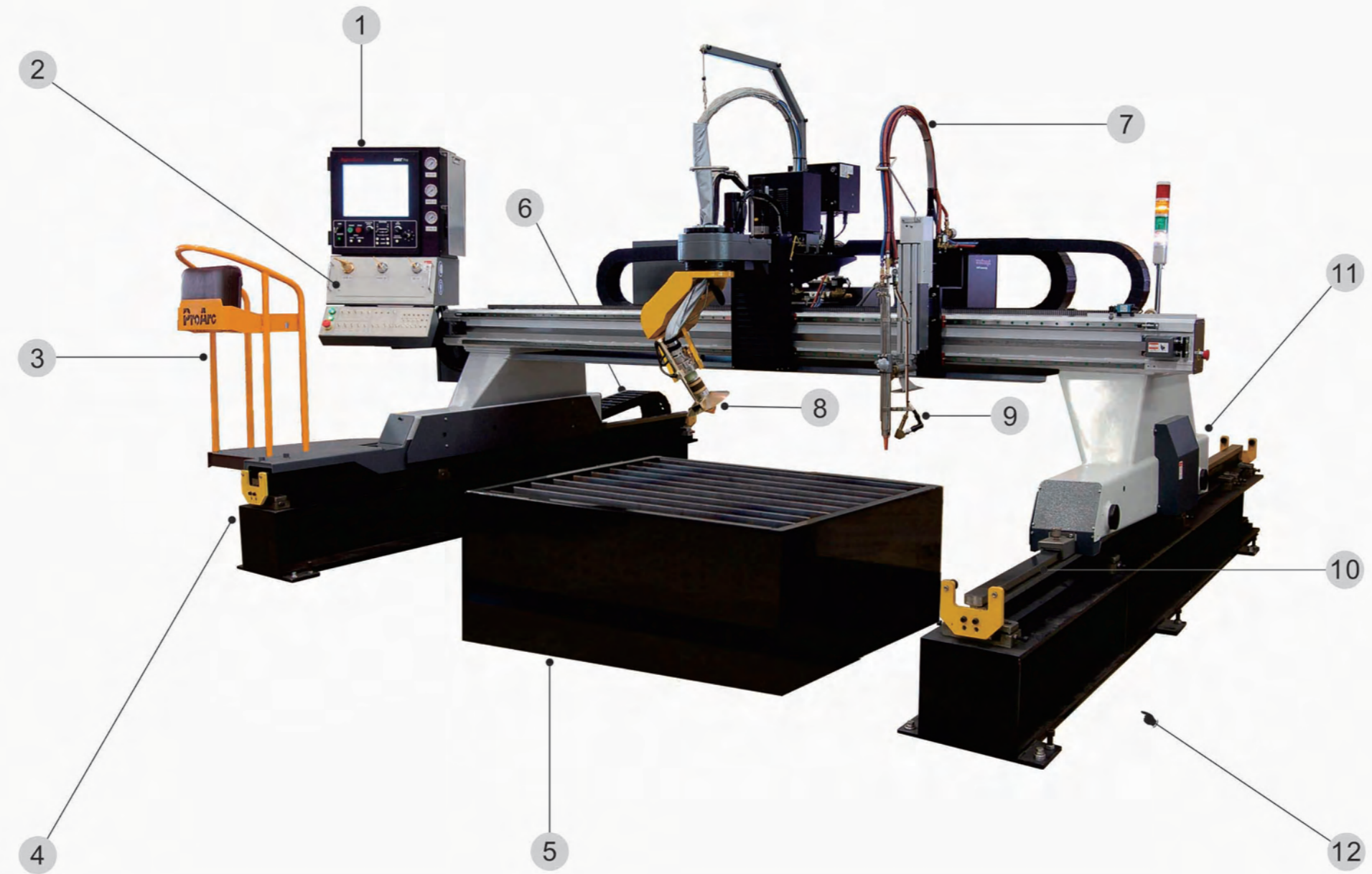
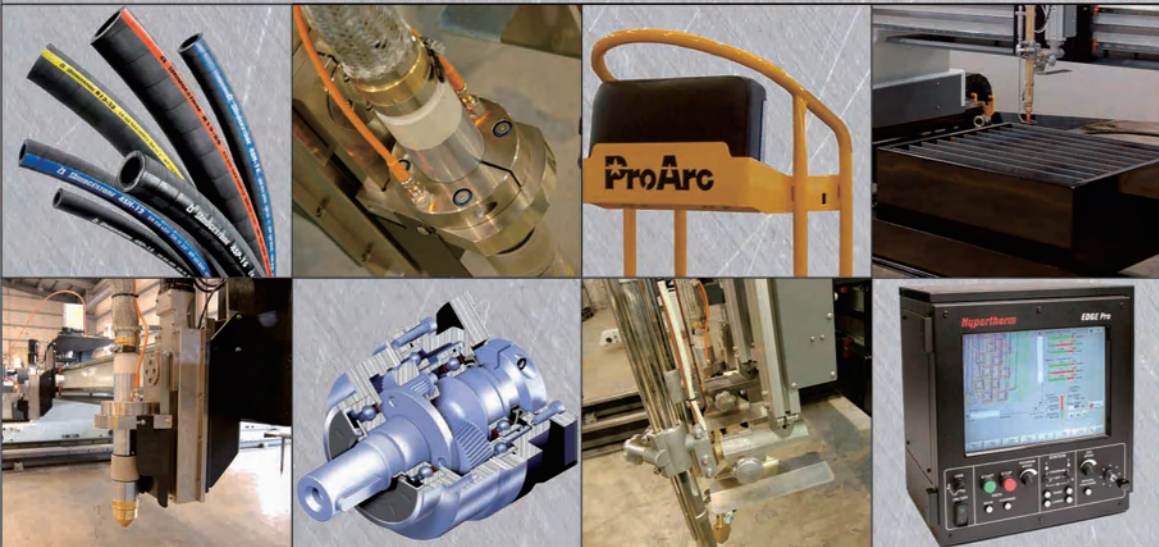

Features

- 1 High performance control system
- 2 Reliable gas distribution system
- 3 Comfortable operation area
- 4 Safety operation
- 5 Clean operation environment
- 6 IGUS cable chain
- 7 BRIDGESTONE hose
- 8 Advanced bevel cut ability
- 9 High quality plasma and flame cutting
- 10 Strong and precision rail
- 11 Stable and reliable drive train system
- 12 The best choice for plasma and flame cutting solution

Adopt consistent design concept

ProArc Master series is a versatile and reliable gantry cutting machine. Master series is designed to be a stable and cost-effective product to meet the need of all cutting sizes. It enables every business to be more productive with oxy-fuel and plasma cutting. ProArc Master is your high performance machine for quality production cutting.

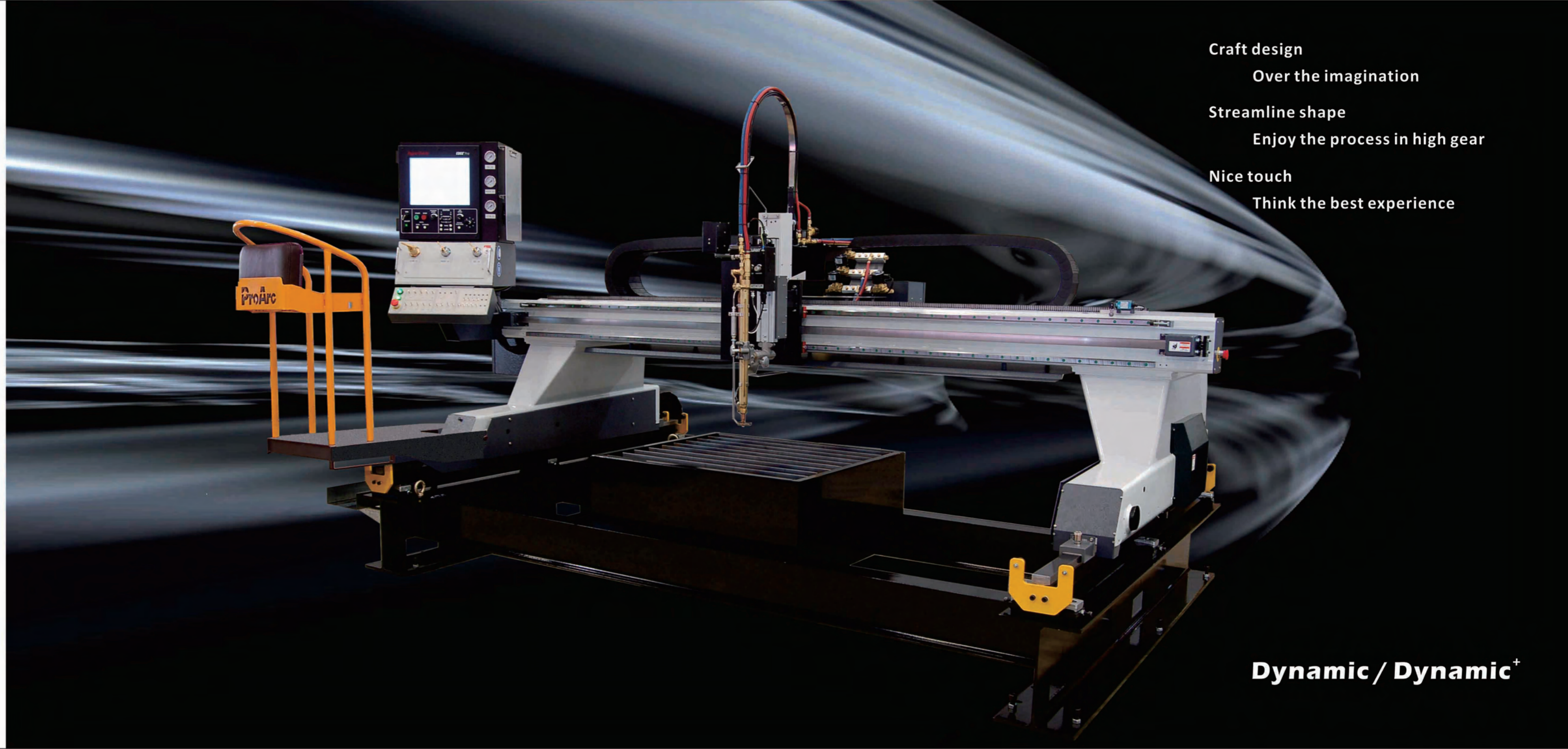

Craft design

Over the imagination

Streamline shape

Enjoy the process in high gear

Nice touch

Think the best experience

Dynamic / Dynamic⁺

Insistence

Quality

- Robust construction
- Accuracy ± 0.1 mm
- Speedy and stable productivity
- High quality and precision plasma cutting

Reliability

- IPC based CNC control system
- Advanced torch height control device
- Advanced anti-collision device
- ProArc sensor THC

Fascinating

- Streamlined shape
- Compact design
- Offered with wide range of optional accessories

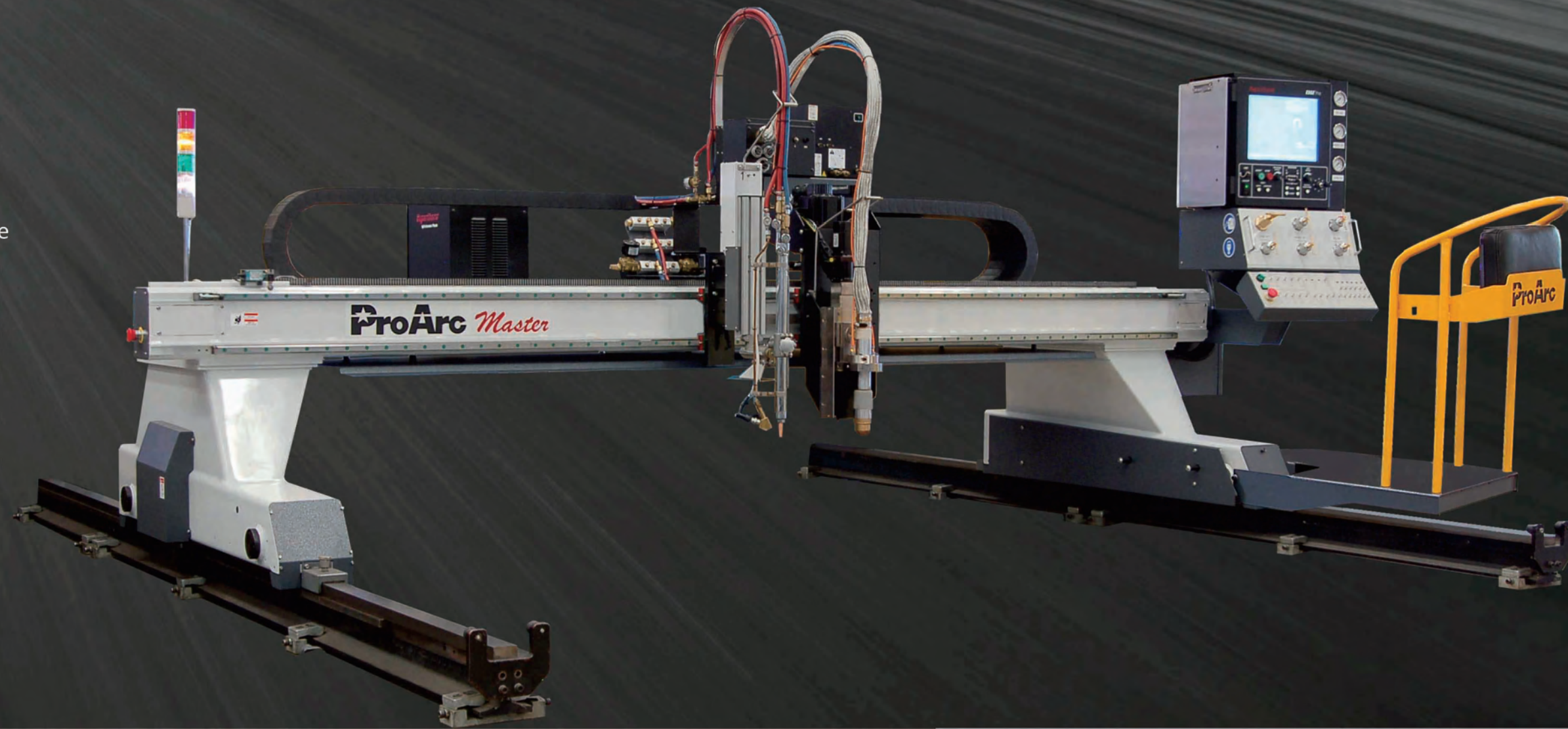

Not only catch your eye but capture your heart!

ProArc streamlined shape CNC cutting machine show your insistence on taste and quality of cutting parts.

Earn your clients' trust from the very beginning

Optional accessories

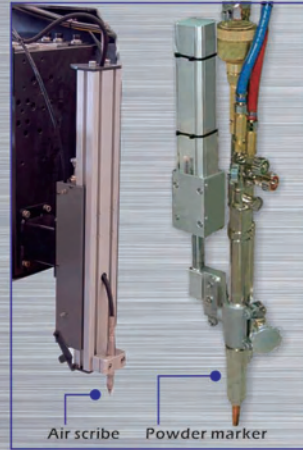

Air scribe and powder marker for layout lines and bend lines

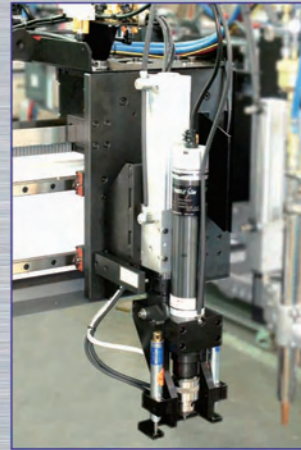

Pneumatic automatic feed pilot drill

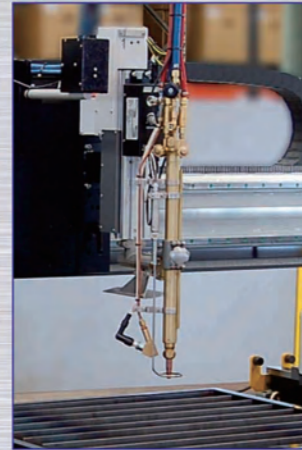

Auto ignition device

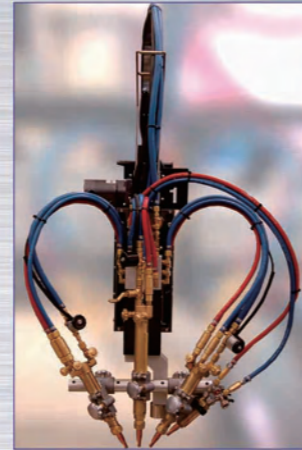

Bevel cutting attachment

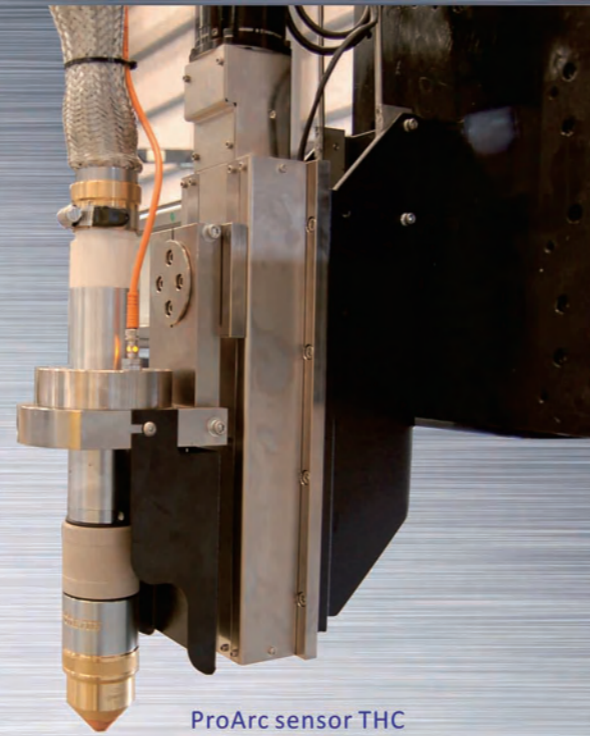

ProArc sensor THC and anti-collision device

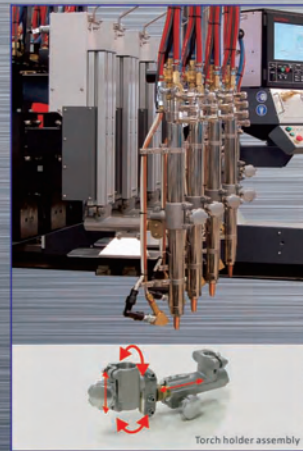

Motorized torch holder



Non-powered steel belt unit

- Torch height sensing control
- Gas Hi/Lo preheat control
- Dual stage piercing control
- Expert cut software
- Motorized torch station
- Auto ignition device
- Water spray device
- Bevel cutting attachment
- Zinc powder or plasma marking
- Air scribe marker
- Pneumatic automatic feed pilot drill

- ProArc plasma sensor THC
- Laser point positioning unit
- Anti-collision device
- Fume extraction table
- Dust collector system

X-cut

Universal plasma bevel head

- Bevel cutting ability: A = 45°, V = 45°
- High bevel speed
- Heavy duty construction
- Full collision detection for torch
- "Expert Motion" controller for tilt and rotation axes
- Automatic torch height control

Specification	
Beveling angle	±45°
Rotation speed	30 rpm
Height control accuracy	±0.1 mm
Tilt accuracy	±0.25°
Rotation accuracy	±0.25°
Overall accuracy	±0.5°

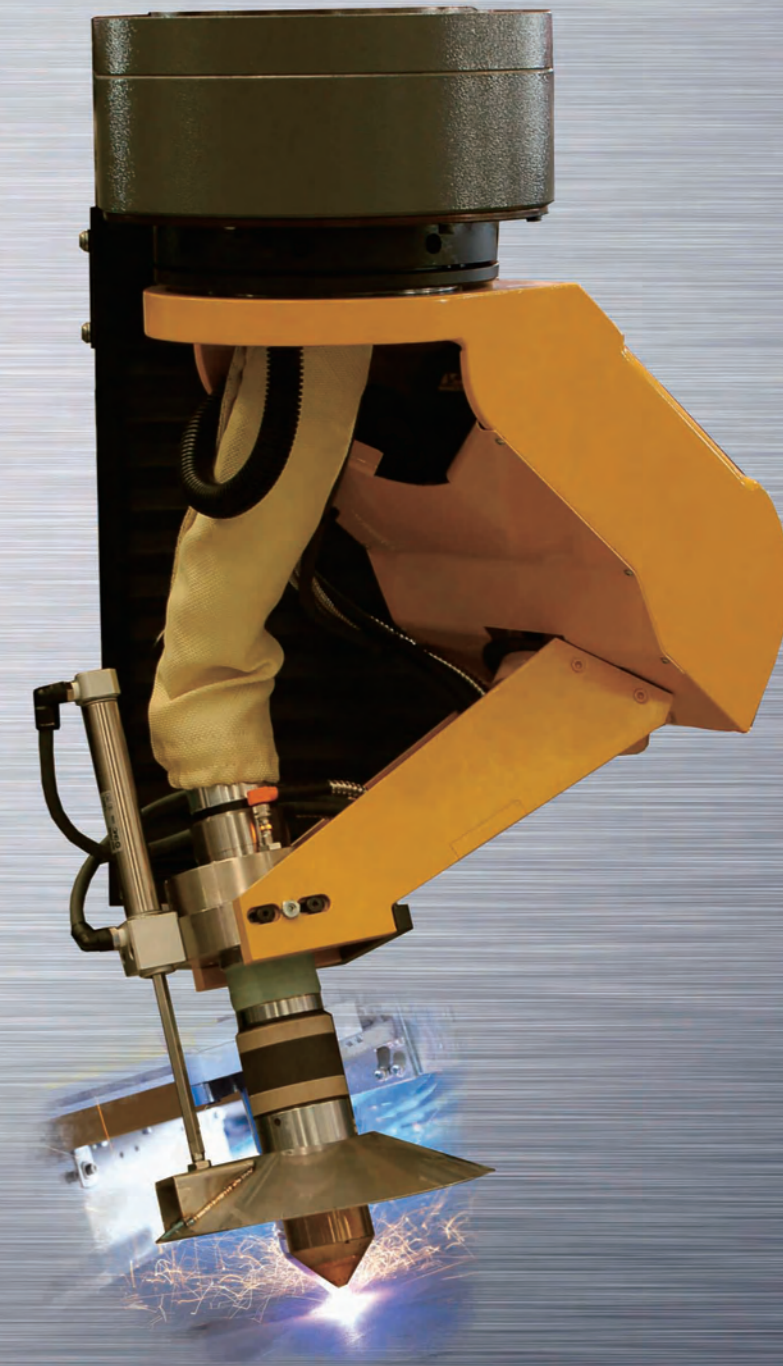
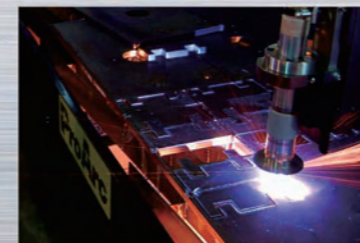

Extraction table

During the plasma, flame or laser cutting processes, the sparks, fumes and dust are pushed into the table and get swirled up again to the top. The metal dust can build up to become health nuisances.

ProArc designs an ideal extraction table. The particles and sparks are pre-separated at the bottom, gases and finer particles are sucked into the duct.

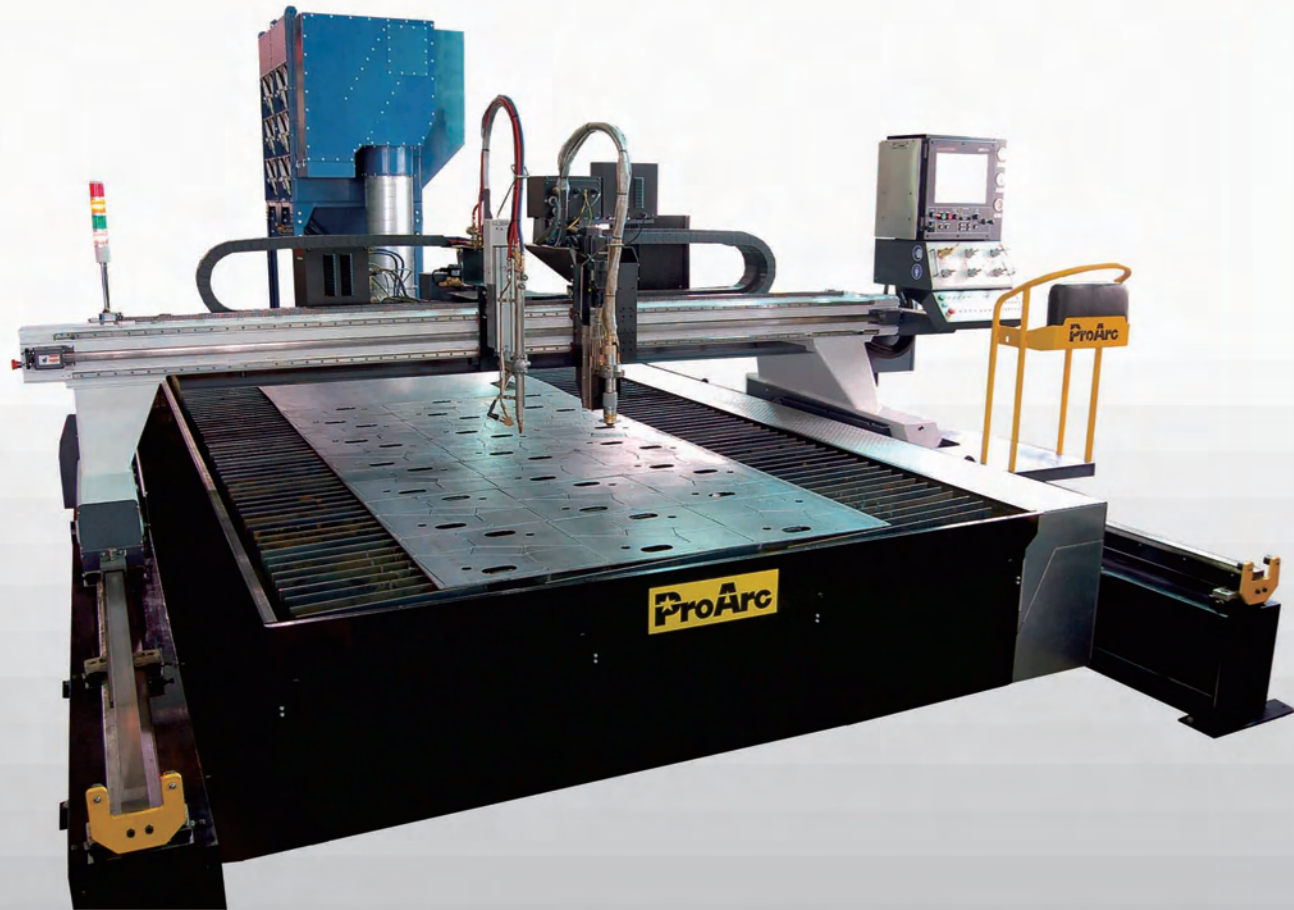

ProArc Dust Collector give you a clean and healthy operation environment.



Long service life

Mechanical concept without any electronic kit for the gate.

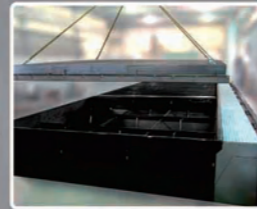

Removable fume table bracket

Loaded and replaced easily. Slag and dross won't be flashing back due to min. angle design.

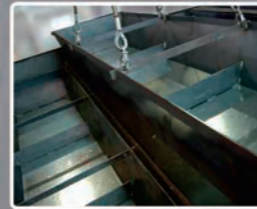

Removable scrap bucket

Easy to clean. Easy to install.

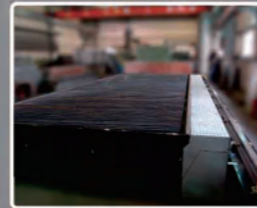

High efficiency

Low power consumption. Single duct with multiple air path for maximum fume collection.

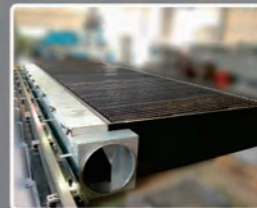

Small space

Easy for transportation. Save installation time at job site.

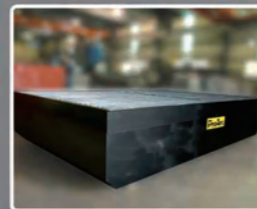

Modular construction

Can be joined together to achieve any desired cutting bed size.

ProArc dust collectors

Model	Number of Filters	Number of Valves	Filter Area (m ²)	Dimension (mm)		
				A	B	C
DC 2-8	8	4	140	1,600	2,910	2,160
DC 3-12	12	6	210	1,600	3,380	2,160
DC 3-18	18	9	310	2,110	3,680	2,160
DC 3-24	24	12	420	2,630	3,680	2,160
DC 3-30	30	15	530	3,150	3,680	2,160
DC 3-36	36	18	630	3,660	3,680	2,160

*The first number indicates number of filter rows, and the second number indicates number of filter cartridges.
**Blower is included.

Fumes, small particles and the airborne remains of molten metal must be dealt with effectively by means of professional extraction and filtration. This ensures that workers feel better, enabling them to perform better. The result is higher productivity and lower absenteeism through sickness.

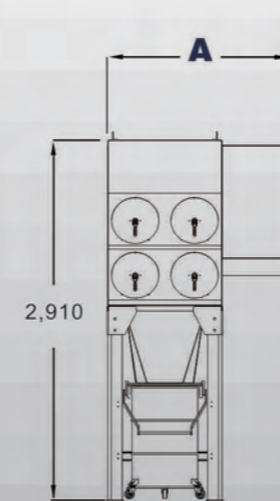

Front View
DC 2-Models

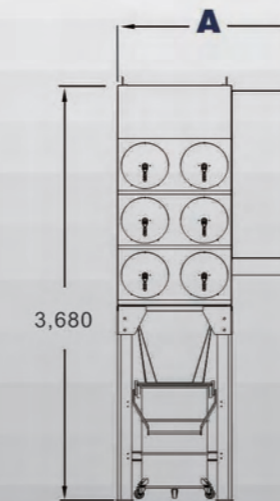

Front View
DC 3-Models

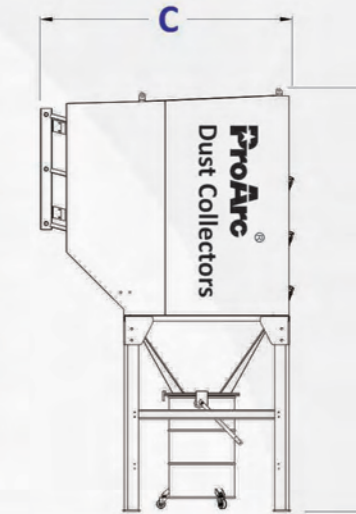

Side View
All Models

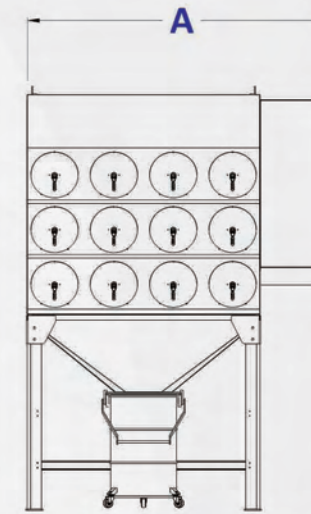

Front View
DC 3-24



DC 3-24

WE PROVIDE:
Total Cutting Solution

CNC cutting machine

Fume extraction table

Dust collectors with inverter fan

H-Beam foundation

ProArc
We love metal arts